

Vermaßung Perspektive

Rahmenteile: STV-SL U3001-1 AVU FAB SKG UMV2 RS
DIN LS spiegelbildlich

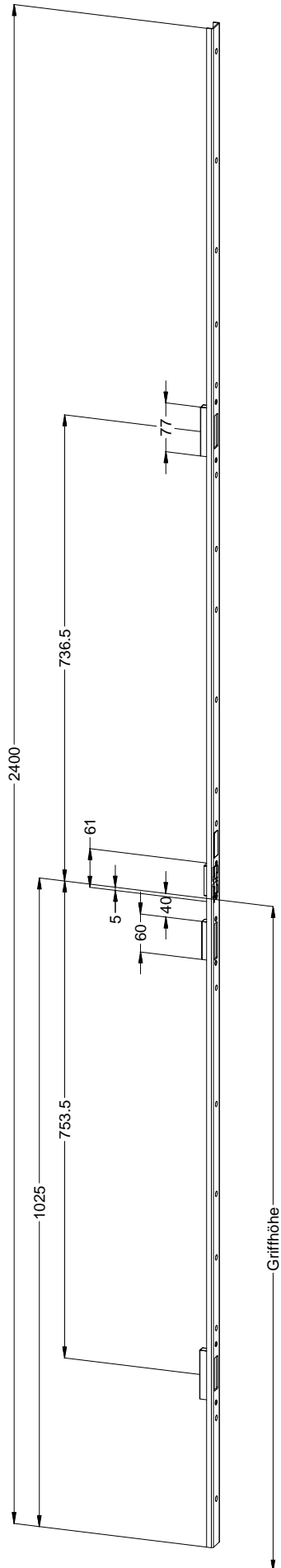

Technische Änderungen vorbehalten!

Schraublage
Rahmenteile:

STV-SL U3001-1 AVU FAB SKG UMV2 RS
DIN LS spiegelbildlich

Technische Änderungen vorbehalten!

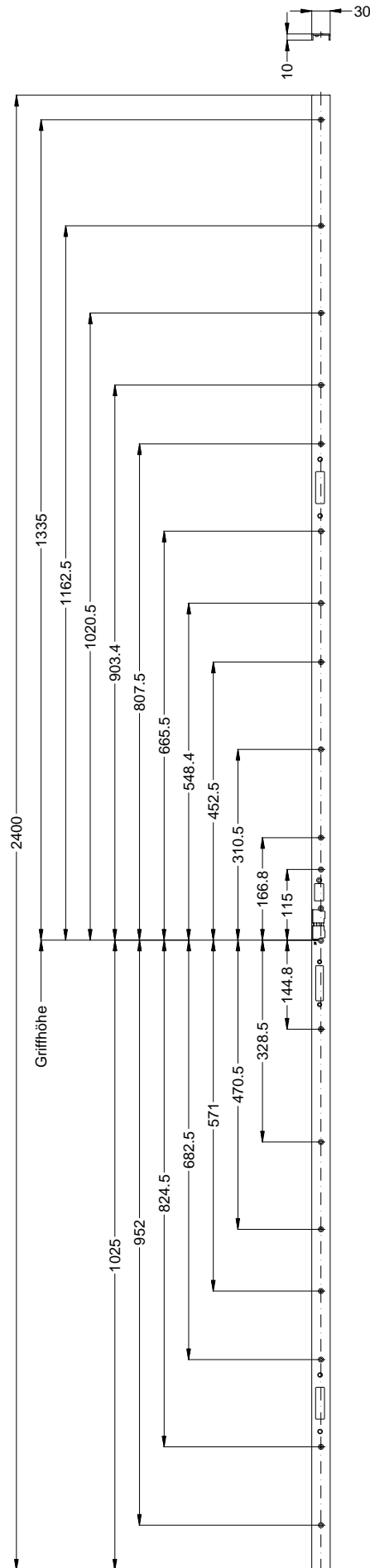

Empfohlene Fräsung

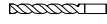
Ø 12

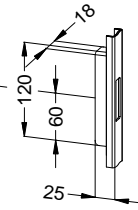

736.5

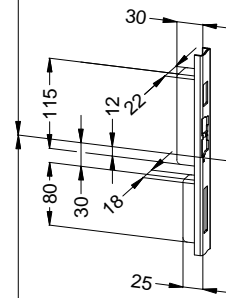

Griffhöhe

753.5

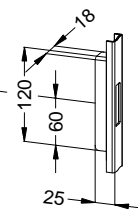

1025

736.5

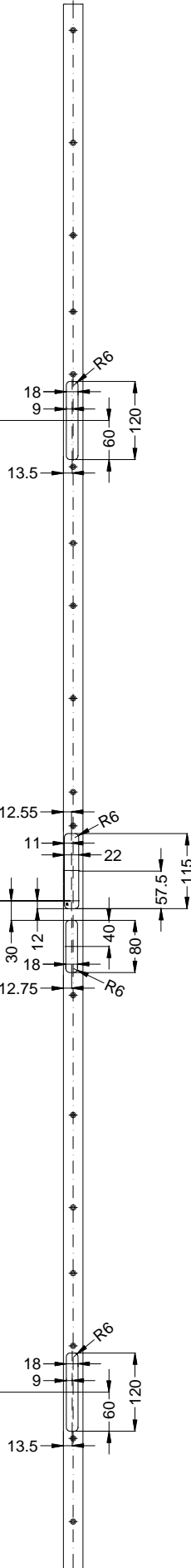

Empfohlene Fräsung

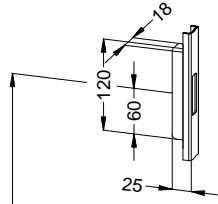
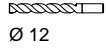

736.5

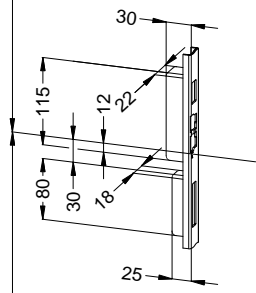

753.5

