

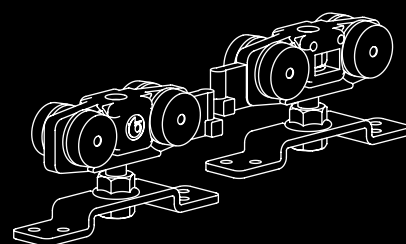

Sync

Simultaneous opening doors
Porte ad apertura simultanea



Sync

Simultaneous opening doors

Porte ad apertura simultanea

EN	Mechanisms for simultaneous opening wooden doors.
IT	Meccanismi per porte in legno ad apertura simultanea.
FR	Mécanismes pour portes en bois à ouverture simultanée.
DE	Mechanismus für Türen aus Holz mit gleichzeitiger Öffnung.
ES	Mecanismos para puertas de madera de apertura simultánea.



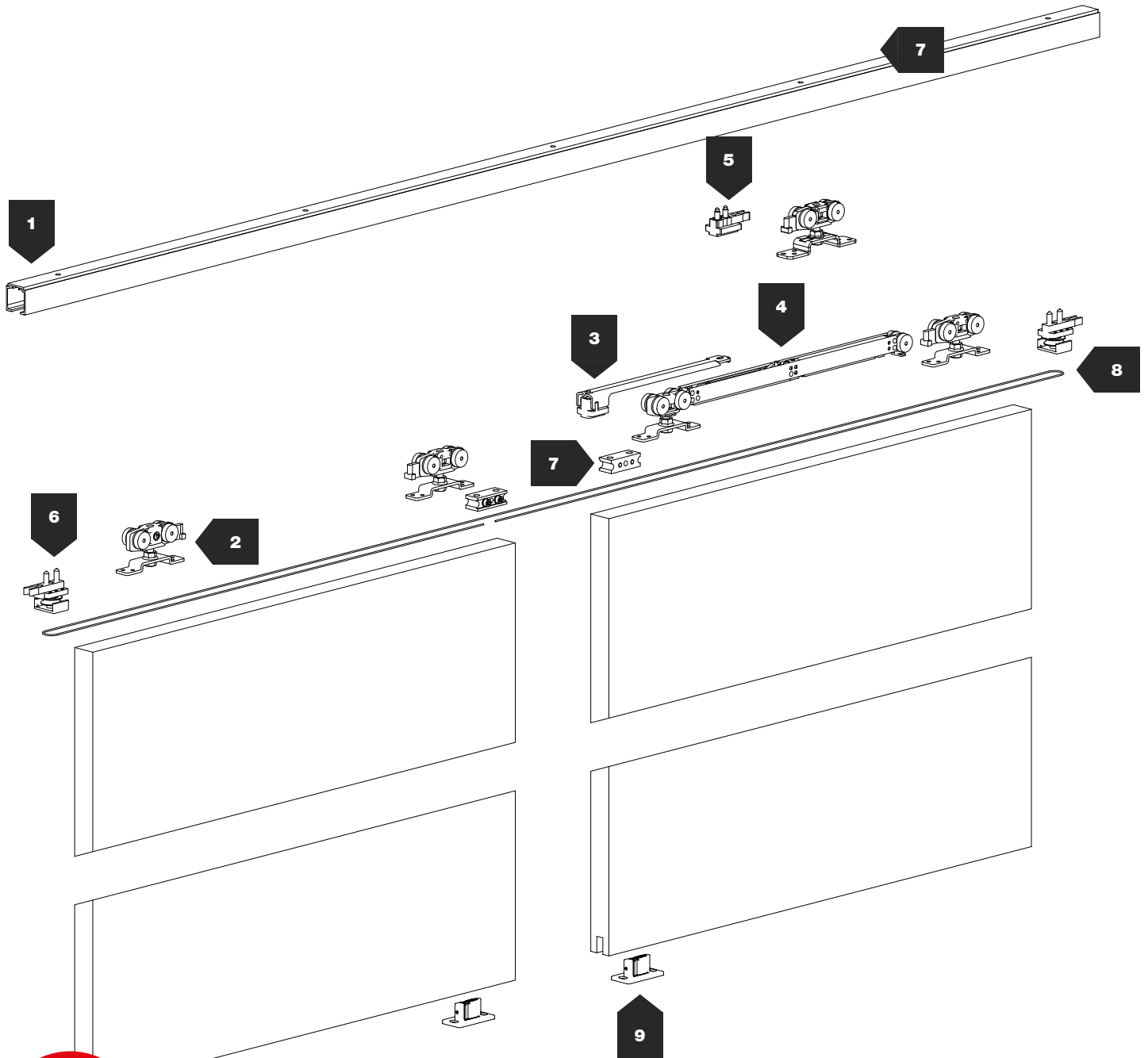

NEW



Min. 30 mm













80 kg



10 mm

Mechanisms for simultaneous opening wooden doors / Meccanismi per porte in legno ad apertura simultanea / Mécanismes pour portes en bois à ouverture simultanée / Mechanismus für Türen aus Holz mit gleichzeitiger Öffnung / Mecanismos para puertas de madera de apertura simultánea

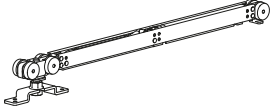
Sync

N°	Barcode		KG		N°	Barcode		KG	
1	1080/1280		80		5	84		80	
2	81/T		80		6	86		80	
	81/T/ES				7	87		80	
3	1674		80		8	88		80	
4	1676/443/80Y		80		9	90		80	

Mechanisms for simultaneous opening wooden doors / Meccanismi per porte in legno ad apertura simultanea / Mécanismes pour portes en bois à ouverture simultanée / Mechanismus für Türen aus Holz mit gleichzeitiger Öffnung / Mecanismos para puertas de madera de apertura simultánea

80 Max 80 Kg each door
Max 80 Kg per porta

Soft air closing
Fermo ammortizzato

CODE	KIT IN BOX
81/1676/86/88	

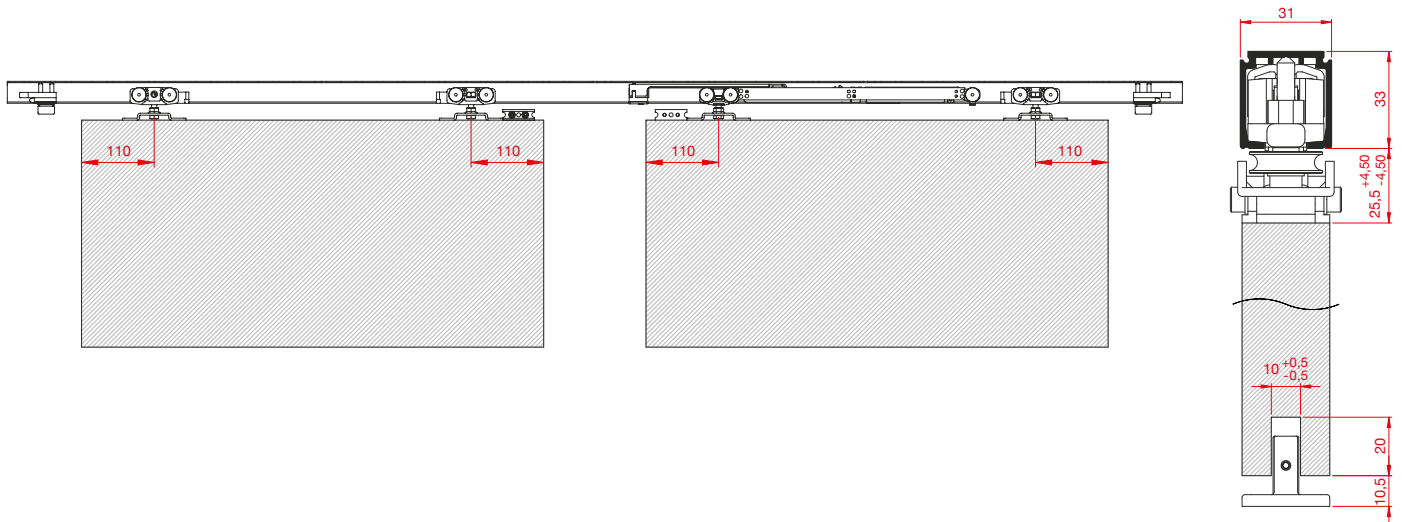

LOWER TRACK / BINARIO INFERIORE

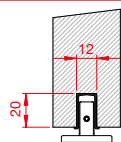

OPTIONAL

ART. 121

Mechanisms for simultaneous opening wooden doors / Meccanismi per porte in legno ad apertura simultanea / Mécanismes pour portes en bois à ouverture simultanée / Mechanismus für Türen aus Holz mit gleichzeitiger Öffnung / Mecanismos para puertas de madera de apertura simultánea

Sync

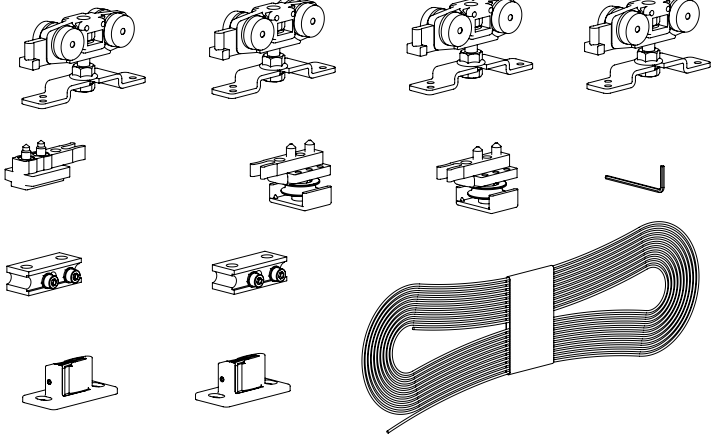
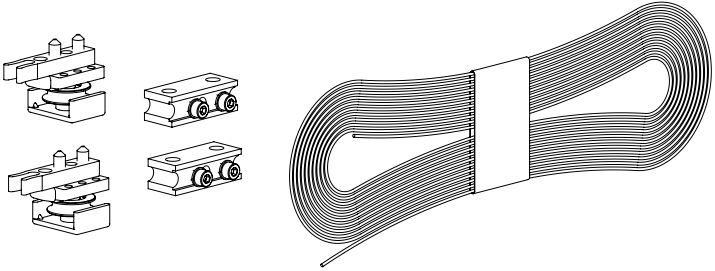
CODE	KIT IN BOX
81/81/86/88	
86/87/88	



Max 80 Kg each door
Max 80 Kg per porta



Classic stopper
Fermo standard

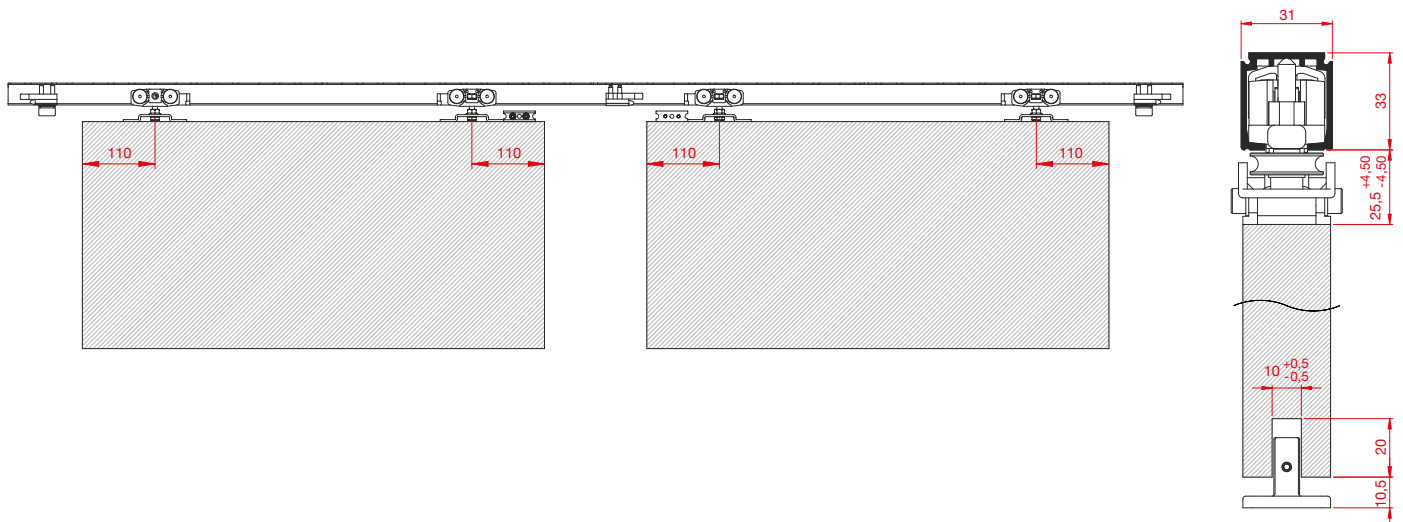

LOWER TRACK / BINARIO INFERIORE

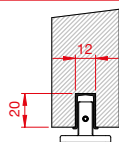

OPTIONAL

ART. 121

