

Modell: Balancer bis 9 kg
Best.-Nr.: 90801027000



Pos.	Best.-Nr.	Benennung	Stück	Status
10	31207134009	Gehäuse	1	*
20	30232031016	Karabinerhaken	1	*
40	30217328001	Bolzen	1	*
50	42401004083	Scheibe	2	**
60	42634010006	Sicherungsscheibe	2	*
70	40238052007	Spannhülse	1	*
74	30217273003	Bolzen	1	*
75	30901025000	Spiralfeder	1	*
76	40238042008	Spannhülse	1	*
80	32429077010	Deckel	1	**
100	32217219005	Hinweisschild	1	***
110	32217371007	Hinweisschild	1	*
120	30229215002	Lasche	1	*
130	42643003004	Sicherungsring	1	*
140	33806008007	Schnecke	1	*
170	32402032007	Scheibe	1	*
180	30901284005	Spiralfeder	1	*
190	30231023010	Seil	1	*
191	43046001002	Blechschraube	1	*
195	30232026000	Karabinerhaken	1	*
210	32102028002	Seiltrommel	1	*
220	32624030028	Scheibe	2	*
230	32408283003	Scheibe	1	*
240	30903028000	Spiralfeder	1	*

Modell: Balancer bis 9 kg
Best.-Nr.: 90801027000



Pos.	Best.-Nr.	Benennung	Stück	Status
250	33413052001	Bolzen	1	*
260	42616009003	Sicherungsring	1	*
280	33663114006	Zahnrad	1	*
290	32408284001	Scheibe	1	**
300	43046020001	Blechschraube	4	*
310	30240256007	Führung	1	*
320	43070013002	Schraube	2	*
5000	30231030004	Seil	1	*
5010	30232025007	Schäkel	1	*
9000	34101225060	Betriebsanleitung Balancer	1	**

Modell:
Best.-Nr.:

Balancer bis 9 kg
90801027000

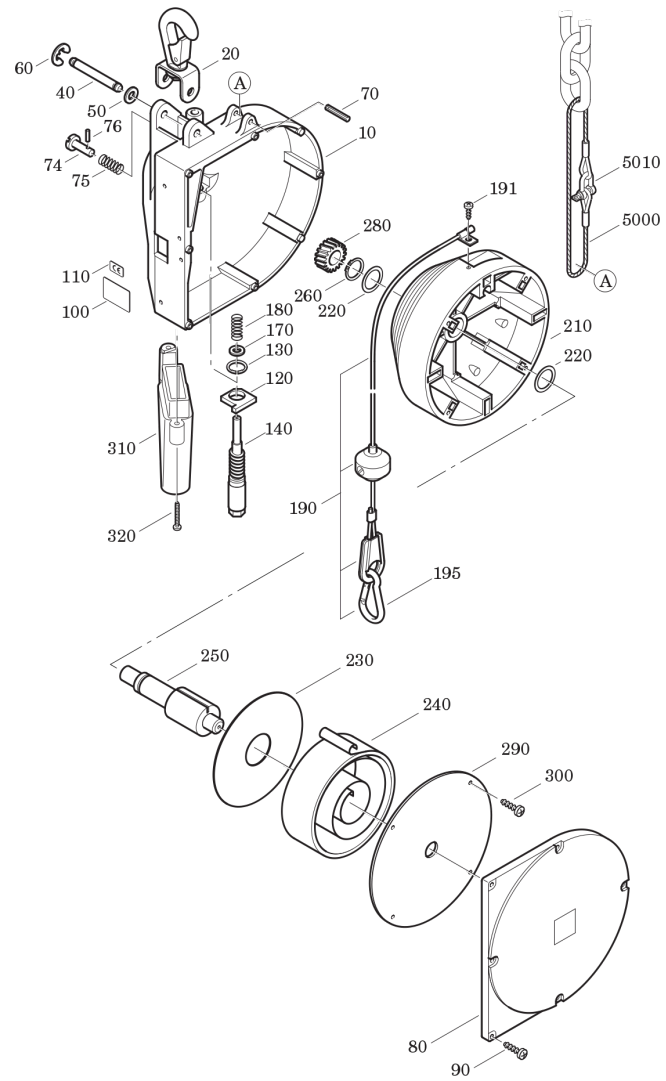

9 08 01 024 00 9
9 08 01 025 00 3
9 08 01 026 00 6
9 08 01 027 00 0
9 08 01 028 00 8
9 08 01 029 00 2
9 08 01 030 00 4
9 08 01 054 00 6

