

**Eng WRDB0E4x Installation Guide**

**Esp Guía de instalación WRDB0E4x**

**Deu Installationsanleitung WRDB0E4x**

**Fra Guide d'installation WRDB0E4x**

**Ned Installatiehandleiding WRDB0E4x**

**Sve Installationsguide WRDB0E4x**

**SALTO**  
inspired access

**WRDx0E4x  
WRDx0E4xK Series**

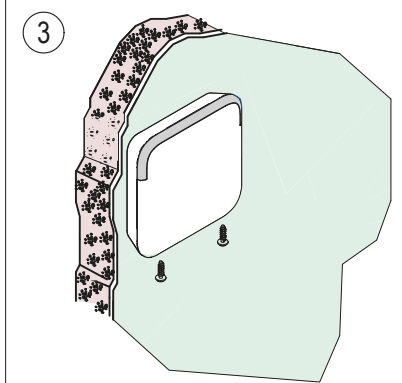
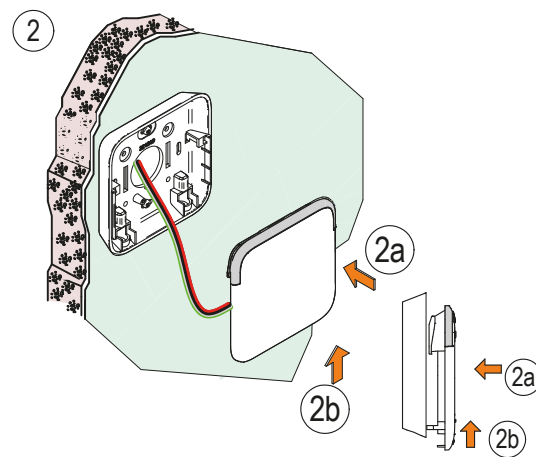
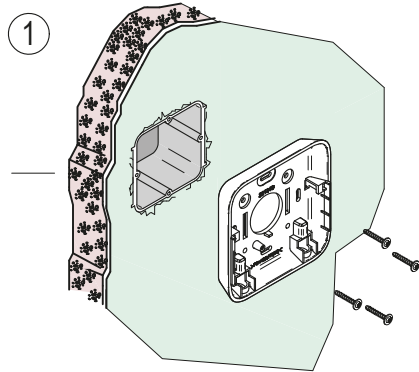
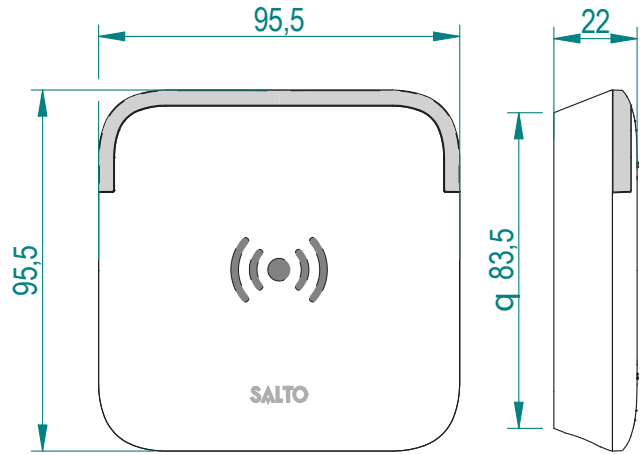
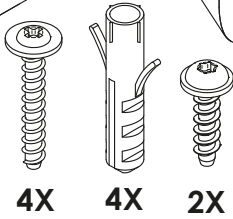
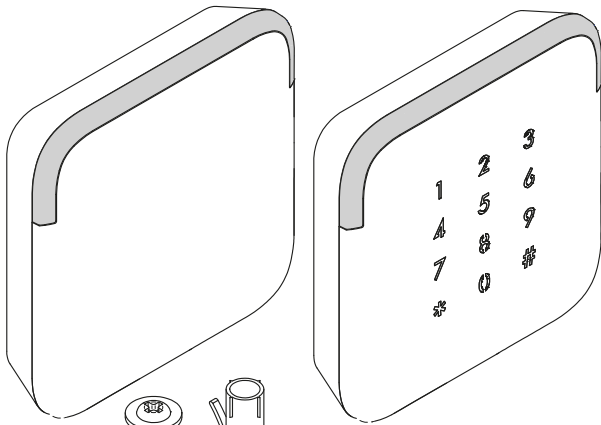

**Eng** GANG ELECTRICAL STANDARD BOX  
**Esp** MODULO CAJA ELECTRICA ESTANDARD  
**Deu** FACH STANDARD SCHALTERDOSE  
**Fra** PLOTS D'ENCASTREMENT STANDARD  
**Ned** STANDAARD ELEKTRISCHE INBOUWDOOS  
**Sve** ELEKTRISK STANDARD BOX

**Eng** TEMPLATE  
**Esp** PLANTILLA  
**Deu** SCHABLONE  
**Fra** GABARIT DE PERÇAGE  
**Ned** SJABLON  
**Sve** MALL

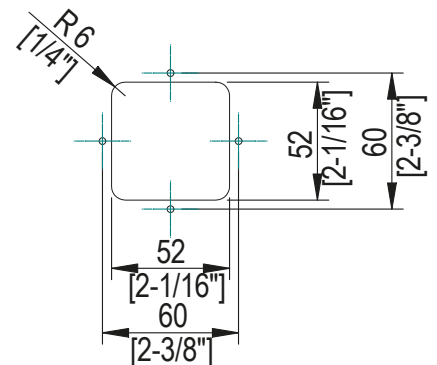
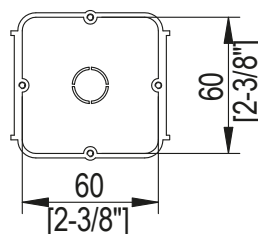
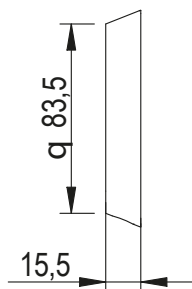
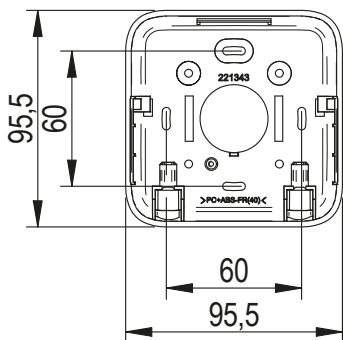

European view

All contents current at time of publication. SALTO Systems S.L. reserves the right to change availability of any item in this catalog, its design, construction, and/or materials.

Eng **Electrical characteristics:**

Operation conditions

	Min	Max	Unit
Temperature	-35	66	°C
Humidity	35	85	%

RF characteristics

	Min	Cen.	Max	Unit
RFID frequency		13.56		Mhz
Bluetooth Smart frequency	2.4	2.445	2.483	Ghz

Power Consumption Note 1

	Min	Max	Unit
Reader		150	mA
Reader+Keyboard		250	mA

Note 1: Installer must take this data into account to dimension the CU42xx power supply

Cable type and max. distances

Cable type	Reader	Reader +Keypad
UTP Cat5e 2 pairs AWG24	100m	60m
UTP Cat5e 4 pairs + SP224861/SP224895	250m	150m
AWG18	400m	280m

Esp **Características electricas**

Condiciones ambientales

	Min	Max	Unit
Temperatura	-35	66	°C
Humedad	35	85	%

Características RF

	Min	Cen.	Max	Unit
Frecuencia RFID		13.56		Mhz
Frecuencia Bluetooth Smart	2.4	2.445	2.483	Ghz

Consumo Nota 1

	Min	Max	Unit
Lector		150	mA
Lector + teclado		250	mA

Nota 1: El instalador ha de tener en cuenta la dimensión del alimentador de la CU42xx

Tipo de cable y distancias max.

Tipo de cable	Lector	Lector +Teclado
UTP Cat5e 2pares AWG24	100m	60m
UTP Cat5e 4 pares + SP224861/SP224895	250m	150m
AWG18	400m	280m

Deu **Elektronische Eigenschaften:**

Umgebungsbedingungen

	Min	Max	Einheit
Temperatur	-35	66	°C
Feuchtigkeit	35	85	%

RF Frequenzen

	Min	Cen.	Max	Einheit
RFID Frequenz		13.56		Mhz
Bluetooth Smart Frequenz	2.4	2.445	2.483	Ghz

Stromaufnahme Note 1

	Min	Max	Einheit
Leser		150	mA
Leser+Keypad		250	mA

Note 1: Bitte beachten Sie die Stromaufnahme bei der Planung des Netzteils für die CU42XX

Verkabelung and max. distances

Kabeltyp	Leser	Leser +Keypad
UTP Cat5e 2Paar AWG24	100m	60m
UTP Cat5e 4 Paar + SP224861/SP224895	250m	150m
AWG18	400m	280m

Fra **Caractéristique électronique**

Condition de fonctionnement

	Min	Max	Unité
Température	-35	66	°C
Humidité	35	85	%

Caractéristiques RF

	Min	Cen.	Max	Unité
Fréquence RFID		13.56		Mhz
Fréquence Bluetooth Smart	2.4	2.445	2.483	Ghz

Consommation Note 1

	Min	Max	Unité
Lecteur		150	mA
Lecteur + Clavier		250	mA

Note 1: l'installateur doit calculer l'alimentation nécessaire pour alimenter la CU42xx .

Type de câble

Type de câble	Lecteur	Lecteur +Clavier
UTP Cat5e 2 paires AWG24	100m	60m
UTP Cat5e 4 paires + SP224861/SP224895	250m	150m
AWG18	400m	280m

Ned **Technische gegevens:**

Omgeving

	Min	Max	Unit
Temperatuur	-35	66	°C
Vochtigheid	35	85	%

RF karakteristieken

	Min	Cen.	Max	Unit
RFID frequency		13.56		Mhz
Bluetooth Smart frequency	2.4	2.445	2.483	Ghz

Voeding in opm 1

	Min	Max	Unit
Wandlezer		150	mA
Wandlezer+Keyboard		250	mA

opm 1: Installateur moet deze info meenemen voor de berekening van de voeding voor de CU42xx

Vermogen en max. afstand

Kable type	Wandlezer	Wandlezer +Keypad
UTP Cat5e 2 pairs AWG24	100m	60m
UTP Cat5e 4 pairs + SP224861/SP224895	250m	150m
AWG18	400m	280m

Sve **Teknisk data::**

frequency

Arbetsområde

	Min	Max	Unit
Temperatur	-35	66	°C
Fukt	35	85	%

RF data

	Min	Cen.	Max	Unit
RFID Frekvens		13.56		Mhz
Bluetooth Smart Frekvens	2.4	2.445	2.483	Ghz

Consumption Not 1

	Min	Max	Unit
Läsare		150	mA
Läsare+Knappsats		250	mA

Note 1: Installatör måste ta med denna information för att beräkna strömåtgång

Kabeltyper och max avstånd

Kabel	Läsare	Läsare +Knappsats
UTP Cat5e 2 pairs AWG24	100m	60m
UTP Cat5e 4 pairs + SP224861/SP224895	250m	150m
AWG18	400m	280m

**Eng WRDB0E4x Installation Guide**

**Esp Guía de instalación WRDB0E4x**

**Deu Installationsanleitung WRDB0E4x**

**Fra Guide d'installation WRDB0E4x**

**Ned Installatiehandleiding WRDB0E4x**

**Sve Installationsguide WRDB0E4x**

**Eng Installation example:**

**Esp Ejemplo de instalación:**

**Deu Installationsbeispiel:**

**Fra Exemple d'installation:**

**Ned Installatievoorbeeld:**

**Sve Installationsexempel:**



- Eng** Only connect to CU42xx
- Esp** Solo conectar a CU42xx
- Deu** Nur für Steuereinheit CU42xx
- Fra** Connecter uniquement CU42xx
- Ned** Alleen aansluiten aan CU42xx
- Sve** Ansluts endast till CU42xx

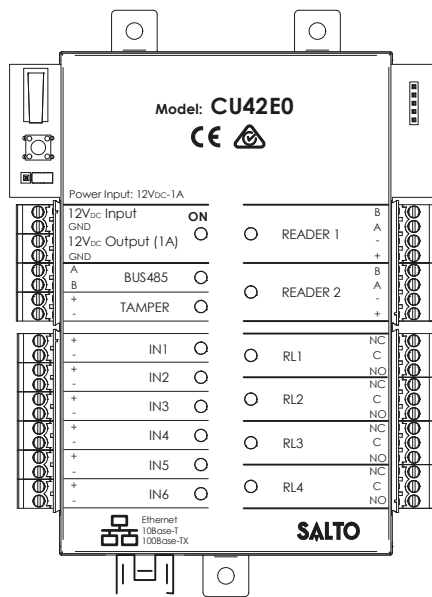

- Eng** Not included
- Esp** No incluido
- Deu** Nicht enthalten
- Fra** Non inclus
- Ned** Niet inbegrepen
- Sve** Ingår inte

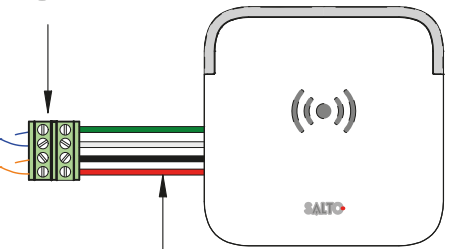

- Eng** Same pair
- Esp** Mismo par
- Deu** Gleiches Paar
- Fra** Même paire
- Ned** Hetzelfde paar
- Sve** Samma par
- Eng** Red
- Esp** Rojo
- Deu** Rot
- Fra** Rouge
- Ned** Rood
- Sve** Röd

**Eng Installation example with RJ45:**

**Esp Ejemplo de instalación RJ45:**

**Deu Innstallationsbeispiel für RJ45:**

**Fra Exemple d'installation avec connecteur RJ45 :**

**Ned Installatie voorbeeld RJ45:**

**Sve Installationsexempel RJ45:**

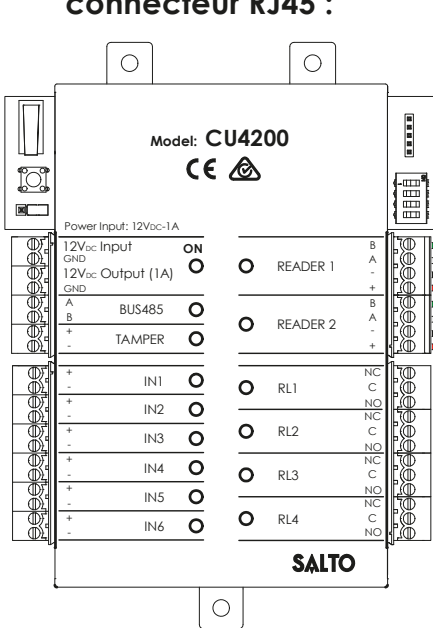

Optional  
Opcional  
Optioneel  
Optionelle  
Facultatief  
Valfritt

Optional  
Opcional  
Optioneel  
Optionelle  
Facultatief  
Valfritt

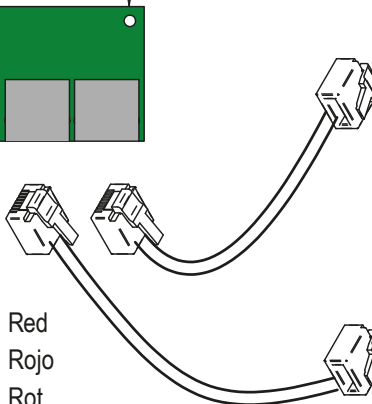

- Eng** Red
- Esp** Rojo
- Deu** Rot
- Fra** Rouge
- Ned** Rood
- Sve** Röd

- Eng** Red
- Esp** Rojo
- Deu** Rot
- Fra** Rouge
- Ned** Rood
- Sve** Röd

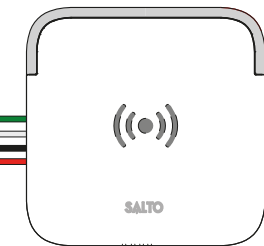

Eng **SIGNALLING**

Signal	Light	Time (sec)	Buzzer	Time (sec)
Card Rejection	Red	1	High pitched 50/50	1
Privacy or emergency status	Red 5x(50/50x3+off300)	3	High pitched 5x(50/50x3 + off 300)	3
Standard opening	Green	1	Low pitched	0,3
Standard locking	Red	0,5	Low pitched	0,2
Open plus office	Green 400/200	2,4	High pitched/Low pitched 400/200	2,4
CLR Button	Orange	Cont.	High pitched	Cont.
Reset	Orange 50/100	450 msg	Low pitched 50/100	450 msg

Esp **SEÑALECTICA**

Señal	Luz	Tiempo (seg)	Buzzer	Tiempo (seg)
Rechazo de Tarjeta	Rojo	1	Agudo 50/50	1
Rechazo por Privacidad o Emergencia	Rojo 5x(50/50x3+ apagado 300)	3	Agudo 5x(50/50x3 + apagado 300)	3
Apertura Normal	Verde	1	Medio	0,3
Cierre Normal	Rojo	0,5	Grave	0,2
Abrir y Paso	Verde 400/200	2,4	Agudo/Grave 400/200	2,4
Botón CLR (3)	Rojo + Verde	Cont.	Agudo	Cont.
Reset	Rojo + Verde 50/100	450 msg	Medio 50/100	450 msg

Deu **SIGNALE**

Signal	LED	Zeit (Sek)	Buzzer	Zeit (Sek)
Karte abgelehnt	Rot	1	Hoher Ton 50/50	1
Bitte-nicht-stören oder Notschließung	Rot 5x(50/50x3+ aus300)	3	Hoher Ton 5x(50/50x3 + aus 300)	3
Normale Türöffnung	Grün	1	Tiefer Ton	0,3
Verschluss der Tür	Rot	0,5	Tiefer Ton	0,2
Office-Mode aktiviert	Grün 400/200	2,4	Hoher Ton /Grave 400/200	2,4
CLR Taste gedrückt	Rot + Grün	Kont.	Hoher Ton	Kont.
Reset	Rot + Grün 50/100	450	Tiefer Ton 50/100	450

Fra **SIGNALISATION**

Signal	Voyant	Temps (sec)	Buzzer	Temps (sec)
Carte rejetée	Rouge	1	Aigu 50/50	1
Privacité ou état d'urgence	Rouge 5x(50/50x3+ off300)	3	Aigu 5x(50/50x3 + off 300)	3
Ouverture Standard	Vert	1	Grave	0,3
Verrouillage Standard	Rouge	0,5	Grave	0,2
Ouverture passage libre	Vert 400/200	2,4	Aigu/Grave 400/200	2,4
Bouton CLR	Rouge + Vert	Cont.	Aigu	Cont.
Reset	Rouge + Vert 50/100	450 msg	Grave 50/100	450 msg

Ned **SIGNALERING**

Signaal	LED indicatie	Time (sec)	Geluid	Time (sec)
Geen rechten	Rood	1	Hoge tonen 50/50	1
Privacy- of noodsluiting	Rood 5x(50/50x3+ off 300)	3	Hoge tonen 5x(50/50x3 + off 300)	3
Standaard opening	Groen	1	Lage tonen	0,3
Standaard sluiting	Rood	0,5	Lage tonen	0,2
Open plus loopstand	Groen 400/200	2,4	Hoge tonen /Grave 400/200	2,4
CLR knop	Rood + Groen	Cont.	Hoge tonen	Cont.
Reset	Rood + Groen 50/100	450 msg	Lage tonen 50/100	450 msg

Sve **Händelse**

Händelse	Ljussignal	Tid (sek)	Buzzer	Tid (sek)
Nekat tillträde	Röd	1	Hög ton 50/50	1
Stör ej eller Nödläge	Röd 5x(50/50x3+ av 300)	3	Hög ton 5x(50/50x3 + av 300)	3
Standard öppning	Grön	1	Låg ton	0,3
Standard stängning	Röd	0,5	Låg ton	0,2
Öppning med kontorsfunktion	Grön 400/200	2,4	Hög ton 400/200	2,4
CLR Knapp	Röd + Grön	Konst.	Hög ton	Konst.
Nollställning	Röd + Grön 50/100	450 ms	Låg ton 50/100	450 ms