

Ferramenta per 2-3 ante in legno a scorrimento inferiore fino a 35 kg con binario di scorrimento avvitato. Ammortizzatore opzionale. Design Forslide

Calcoli

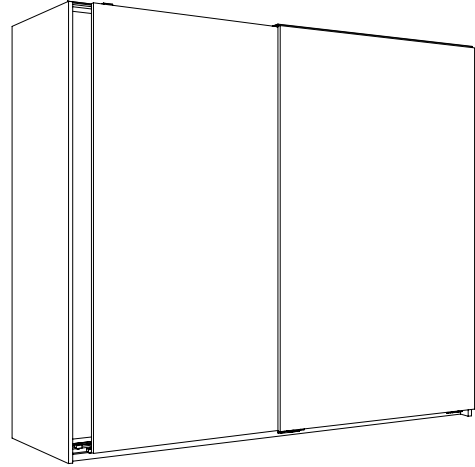

Esempi di montaggio

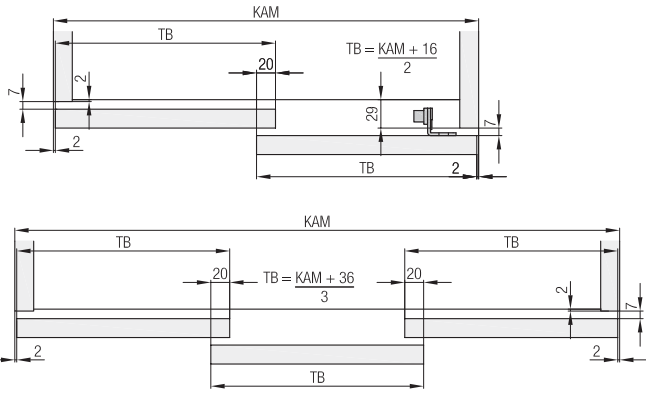
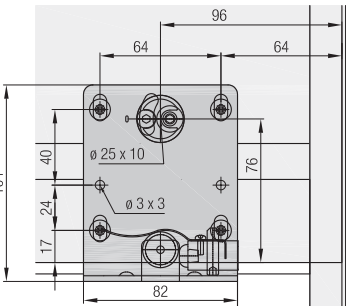
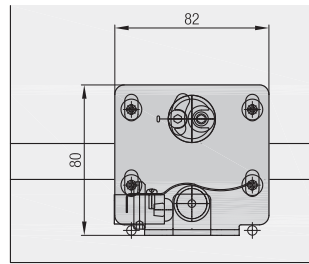
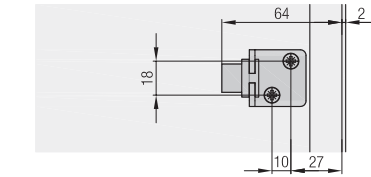
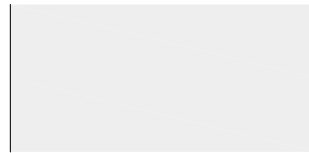
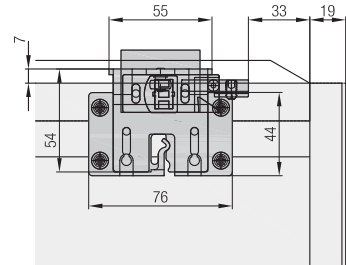
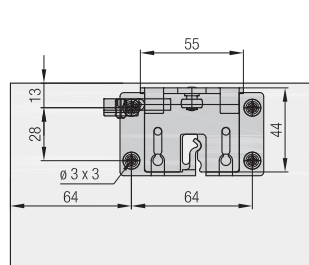
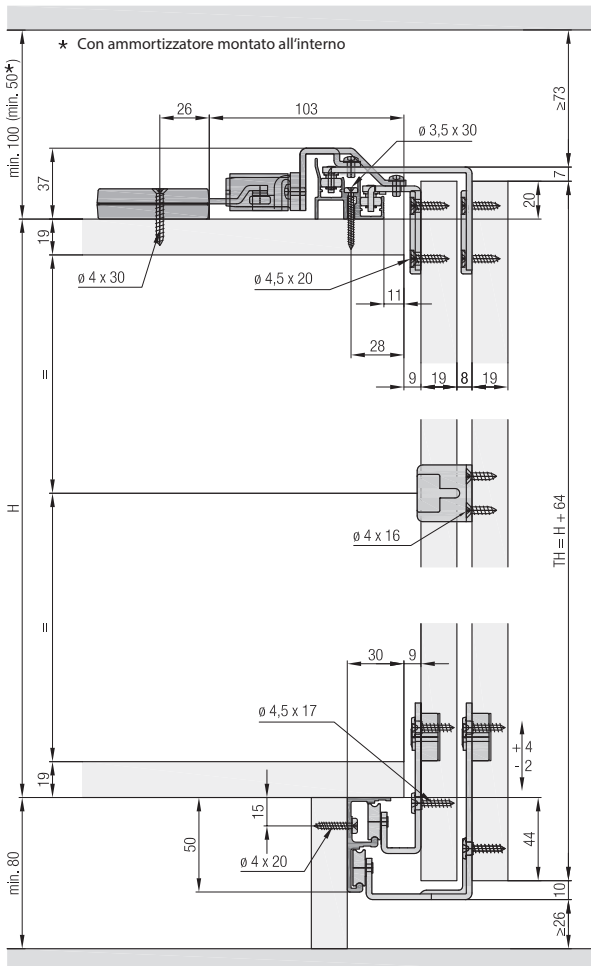

Con riserva di modifiche tecniche

COMBINO 20
38

COMBINO 35
19