



Schema di foratura fermo per anta ribaltabile Kraby L355 mm

Schema foratura con cerniere Kimana

-  - Magnete K Lock
- Incasso o applicazione
-  - K Push Tech 20 mm
- con magnete
- Incasso o applicazione

Cabine (X)		Anta (Y)		L1
16 mm	4 mm	16 mm	2 mm	302
16 mm	4 mm	19 mm	-	304
18 mm	2 mm	18 mm	-	302
19 mm	-	16 mm	2 mm	298
19 mm	-	19 mm	-	300
20 mm	-	20 mm	-	300

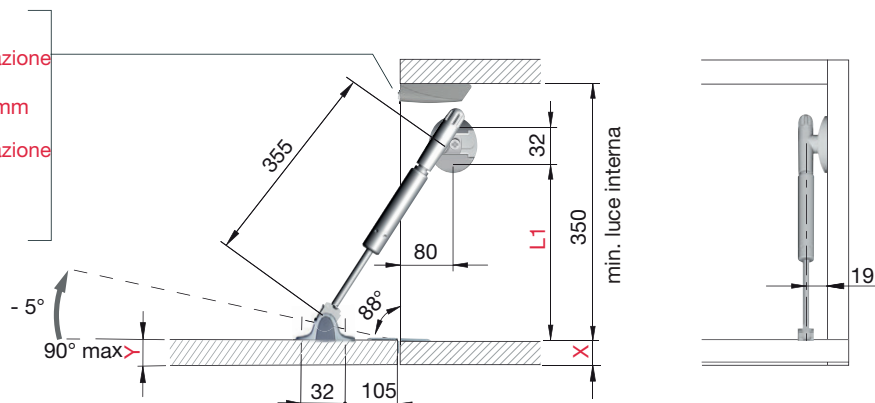

Schema foratura con cerniere con fondello senza Push to Open

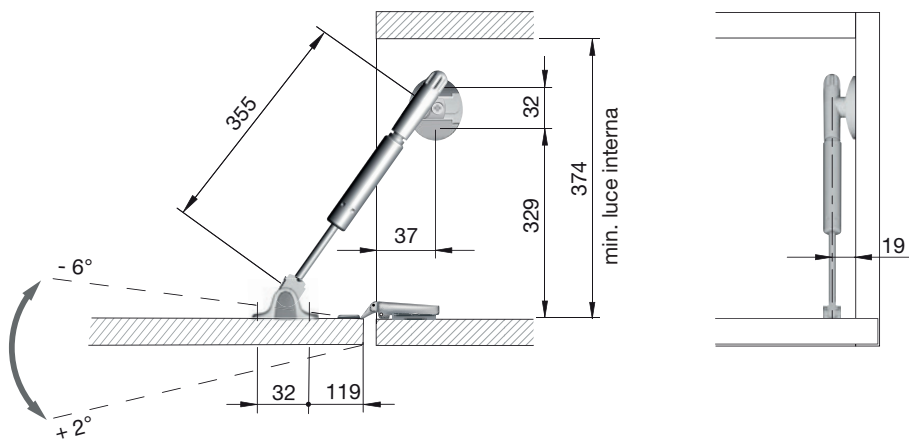

Schema foratura con cerniere con fondello con Push to Open

