

**Schema di foratura fermo per anta ribaltabile K12 foratura L355 mm**

Schema foratura con cerniere Kimana

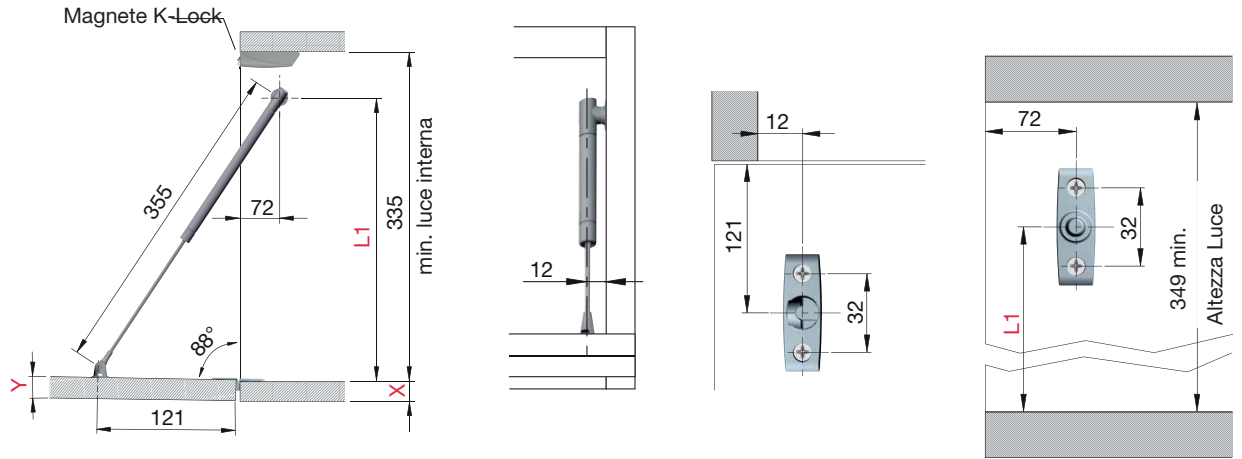

Schema foratura con cerniere con fondello senza Push to Open

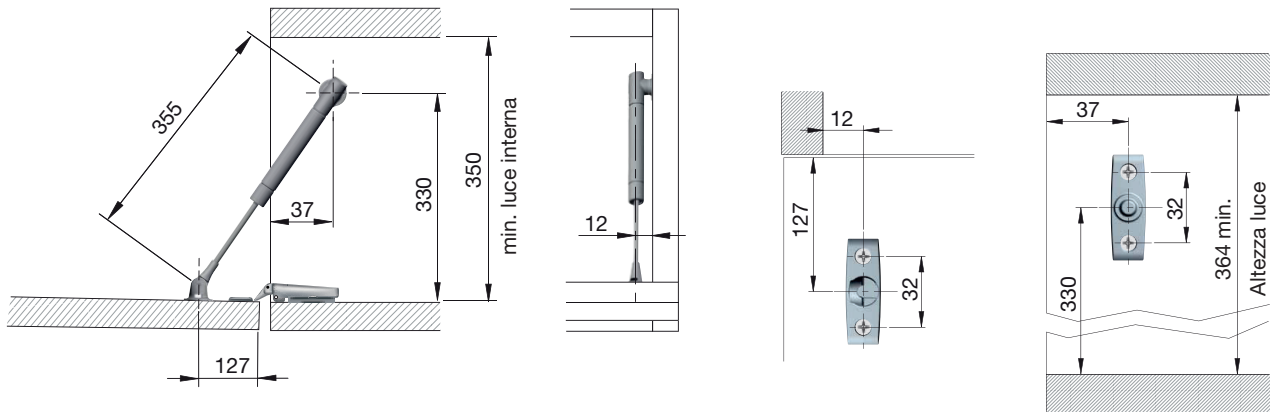

Schema foratura con cerniere con fondello con Push to Open

