

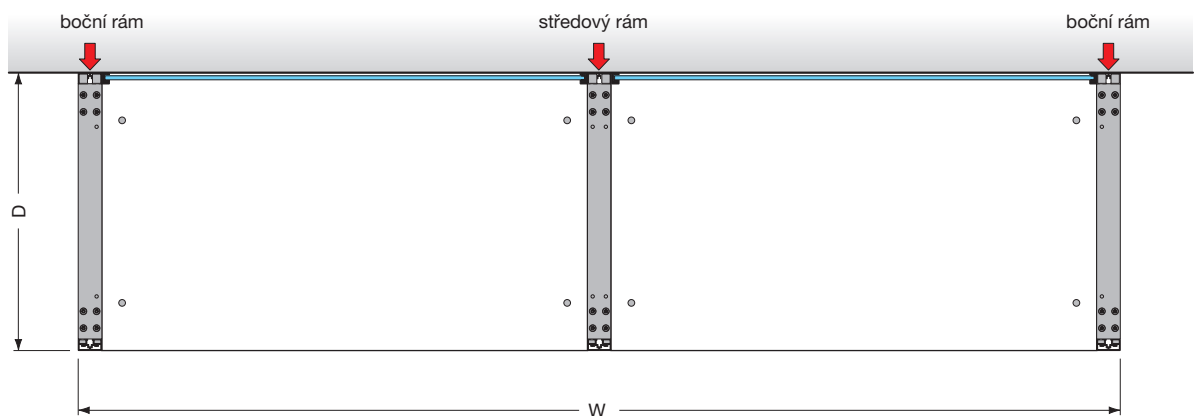

## skleněná zadní stěna

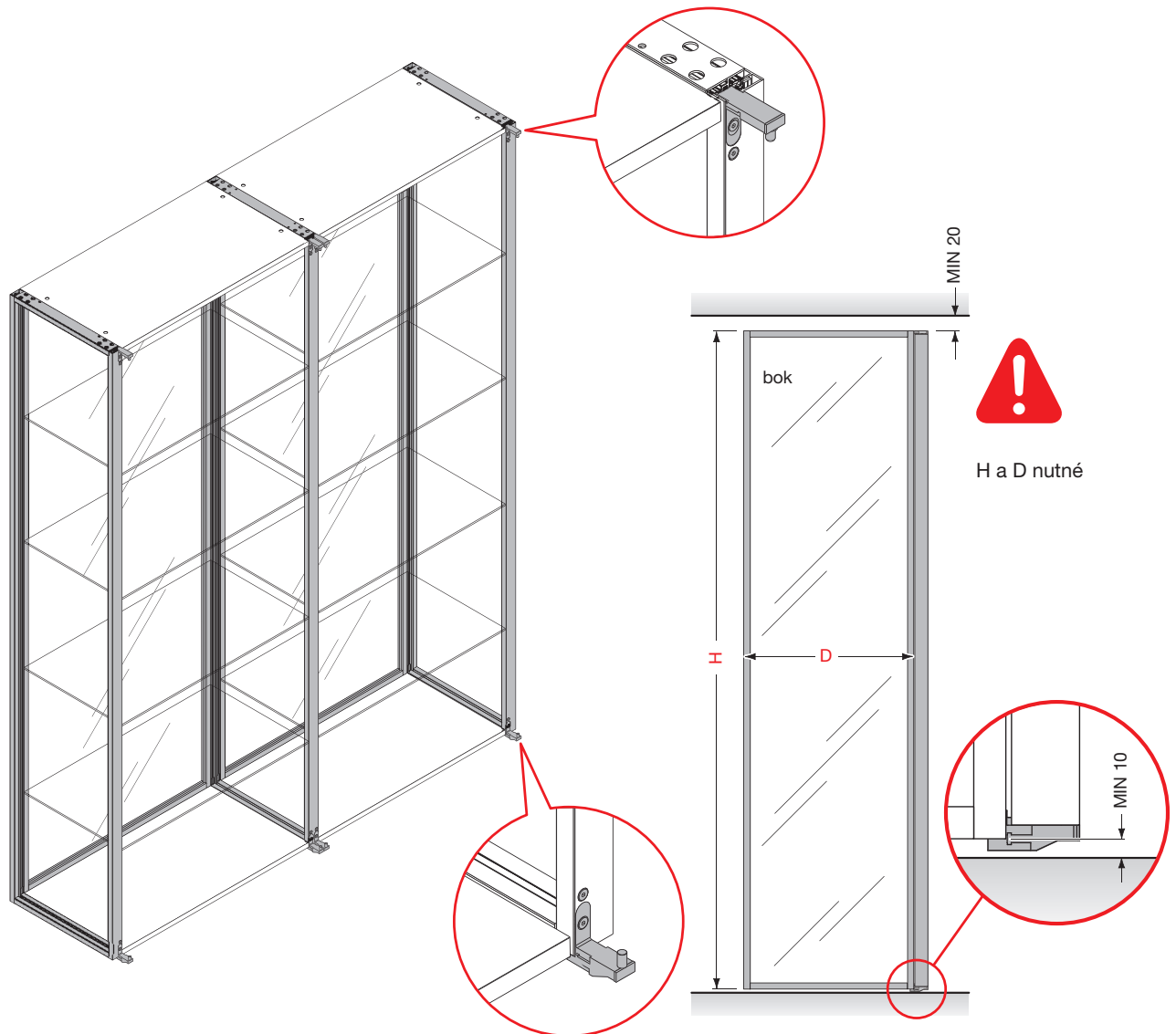

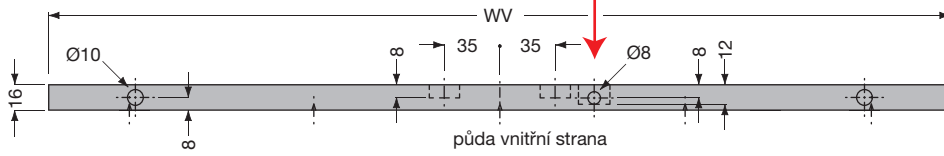

volitelně

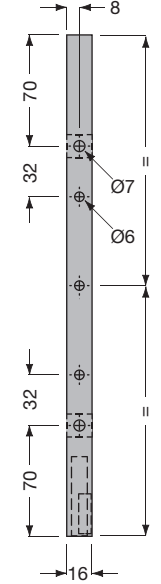
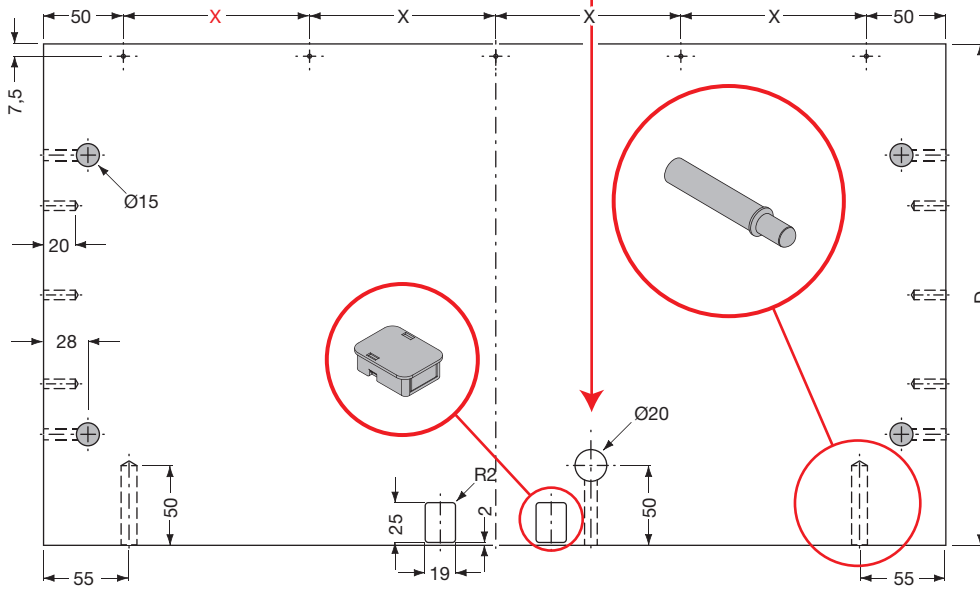
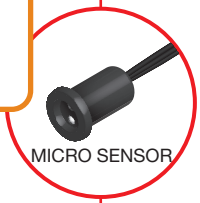

$$X = (WV - 100) : 4$$

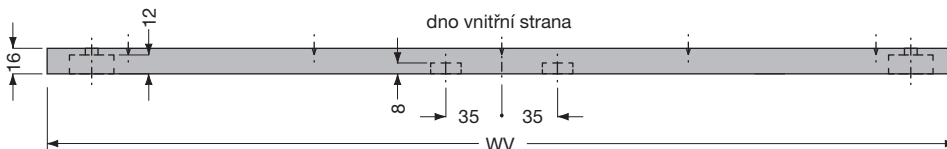
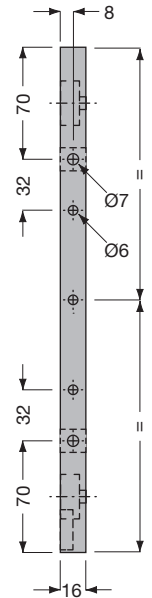
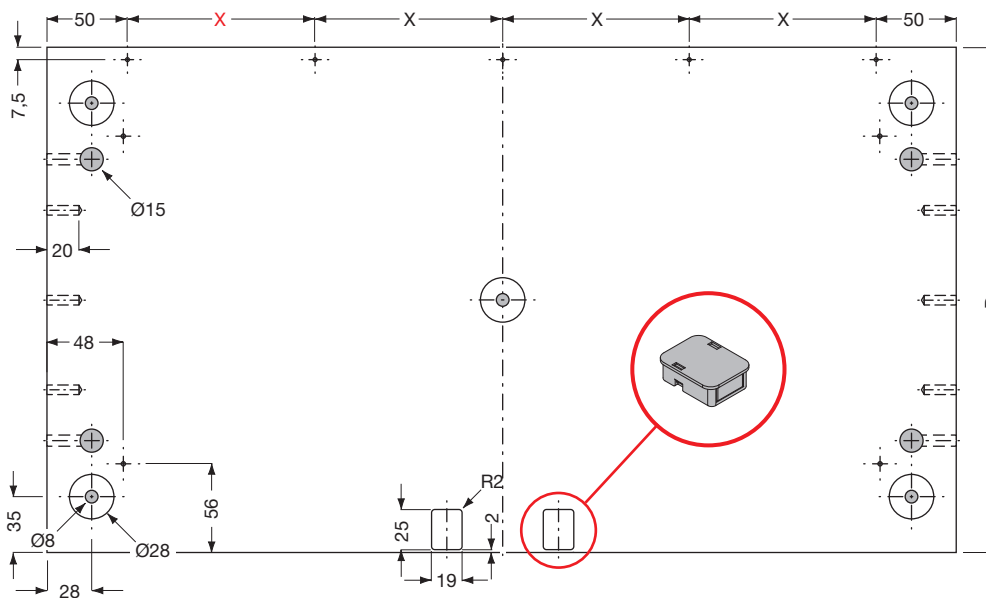

$$X = (WV - 100) : 4$$

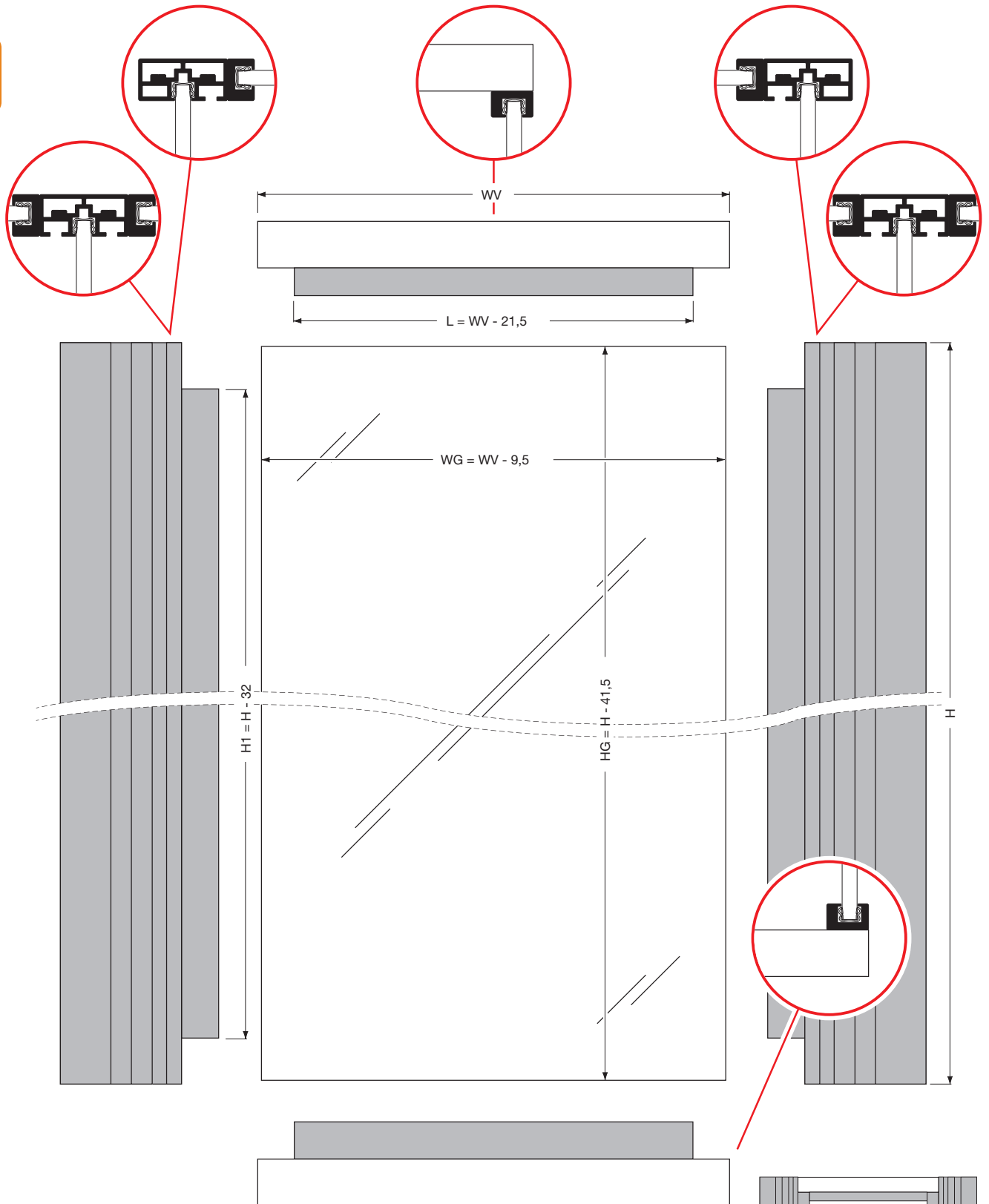

- Zkratky:  
L = délka profilu  
WV = šířka pro vložení  
WG = šířka skla  
H = Gesamthöhe  
H1 = celková výška  
HG = výška skla



← vnitřní strana

