



**GIRO**

1XCR2032 | 3V  
LITHIUM | 0,1 mA

**GIRO**

**A**

**B**

**GIRO**

24VDC Power Supply

max 15mt

**GIRO**

**MATCHING:**

24Vdc

>3 sec.

max. 30sec

<1 sec.

**GIRO**

**MATCHING:**

MASTER

SLAVE

<1 sec.

>7 sec.

10 sec.

**GIRO D-MWA**

M001000072\_r0\_p.1/2



**GIRO**



CONNECTIVITY

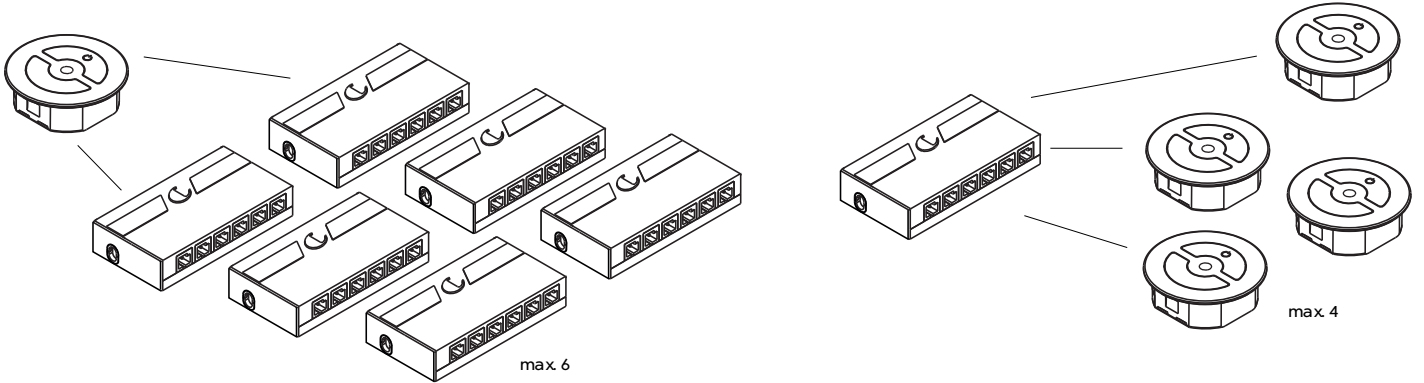

**GIRO D-MWA**

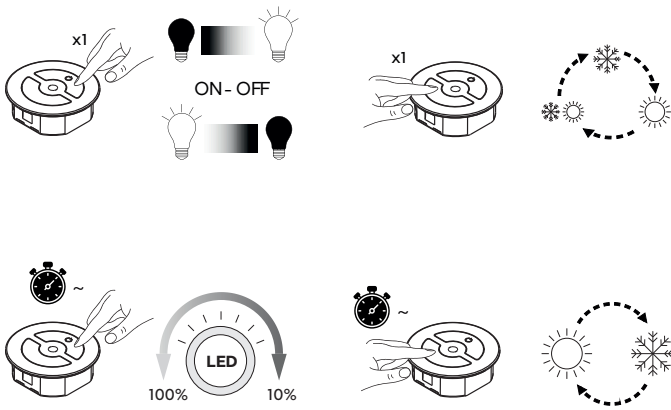

**GIRO**

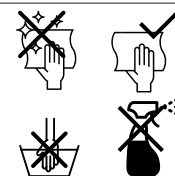
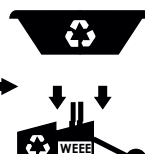
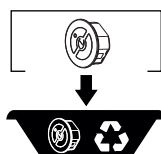
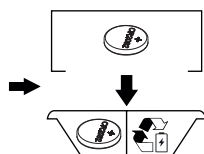
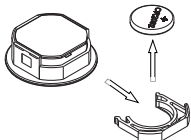
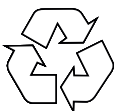
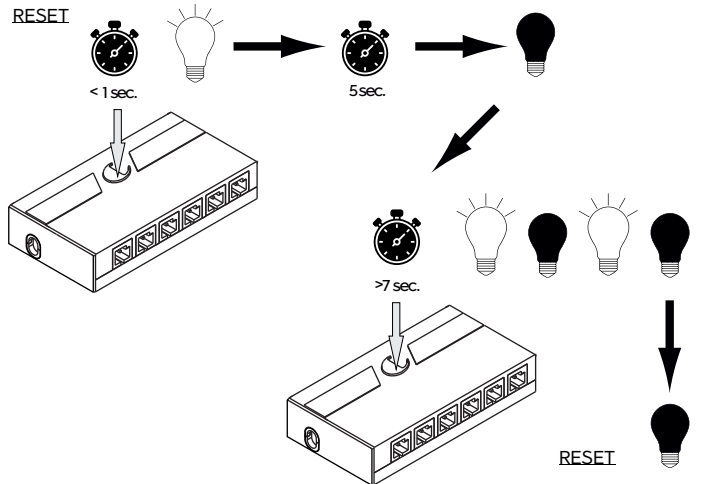

**GIRO D-MWA**