



**MTH**

**MTH-AT**

**MTH-A2**

**MTH-A4**

## MERKMALE

- Funktion nach dem Prinzip des Reibschlusses; kraftkontrollierter Einbau
- Für schwere Lasten
- Zugelassen für zwei Einbautiefen
- Einfache Montage
- Geeignet für ungerissenen Beton
- Vorinstallation oder mit der Bohrung des Anbauteils
- Einsatz für statische oder quasistatische Lasten
- Version aus verzinktem Stahl und aus rostfreiem Stahl, Stufe A2 und A4
- Verschiedene Längen und Größen, flexibler Einbau
- DIN 440 für Befestigungen von Holzbauten an Beton
- Verfügbar in INDEXcal

## BAUSTOFFE



## VERFÜGBARE GRÖSSEN

**M6 - M20**

## BOHRLOCHBEDINGUNGEN



TROCKEN



FEUCHT



MIT WASSER  
GEFÜLLT

## ANWENDUNGEN

- Befestigung von tragenden Anwendungen in ungerissenen Beton
- Sicherheitsbarrieren
- Befestigung von Tafeln, Maschinen, Kesseln, Schildern, Werbeflächen usw.
- Befestigungen von Holzbauten an Beton

## MAX. EMPFOHLENE ZUGTRAGFÄHIGKEIT IN UNGERISSENEM BETON [kg]

### MTH/MTH-AT

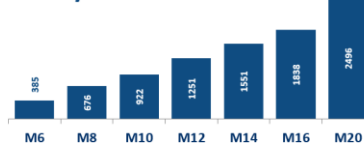

\*M14 Solist für MTH

### MTH-A2/A4

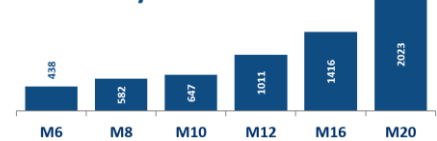

## ANWENDUNGSBEISPIELE

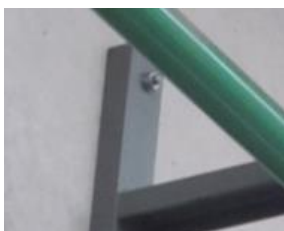

**1. SORTIMENT**

POS.	ART.-NR.	GRÖSSE	FOTO	KOMPONENTE	MATERIAL
1	AH	M6 bis M20		Ankerstange Clip Mutter Scheibe	Kaltgewalzter Kohlenstoffstahl, verzinkt $\geq 5 \mu\text{m}$ Kohlenstoffstahl, verzinkt $\geq 5 \mu\text{m}$ DIN 934 Klasse 6 ISO 898-1, verzinkt $\geq 5 \mu\text{m}$ DIN 125, DIN 9021 oder DIN 440, verzinkt $\geq 5 \mu\text{m}$
2	AHAT	M6 bis M20		Ankerstange Clip Mutter Scheibe	Kaltgewalzter Kohlenstoffstahl, atlantis $\geq 8\mu\text{m}$ Kohlenstoffstahl, atlantis $\geq 8\mu\text{m}$ DIN 934 Klasse 6 ISO 898-1, atlantis $\geq 8\mu\text{m}$ DIN 125, DIN 9021 oder DIN 440, atlantis $\geq 8\mu\text{m}$
3	MI	M6 bis M20		Ankerstange Clip Mutter Scheibe	rostfreier Stahl, Stufe A2 rostfreier Stahl, Stufe A2 DIN 934, rostfreier Stahl, Stufe A2 DIN 125, DIN 9021 oder DIN 440, rostfreier Stahl, Stufe A2
4	MIA4	M6 bis M20		Ankerstange Clip Mutter Scheibe	rostfreier Stahl, Stufe A4 rostfreier Stahl, Stufe A4 DIN 934, rostfreier Stahl, Stufe A4 DIN 125, DIN 9021 oder DIN 440, rostfreier Stahl, Stufe A4

**2. ZUBEHÖR**

POS.	ART.-NR.	FOTO	BESCHREIBUNG
1	DOMTA		Werkzeug zum Einbau von Verankerungen mit Hartmetallbohrer

**3. EINBAUHINWEISE**

**3.1. EINBAUPLAN**

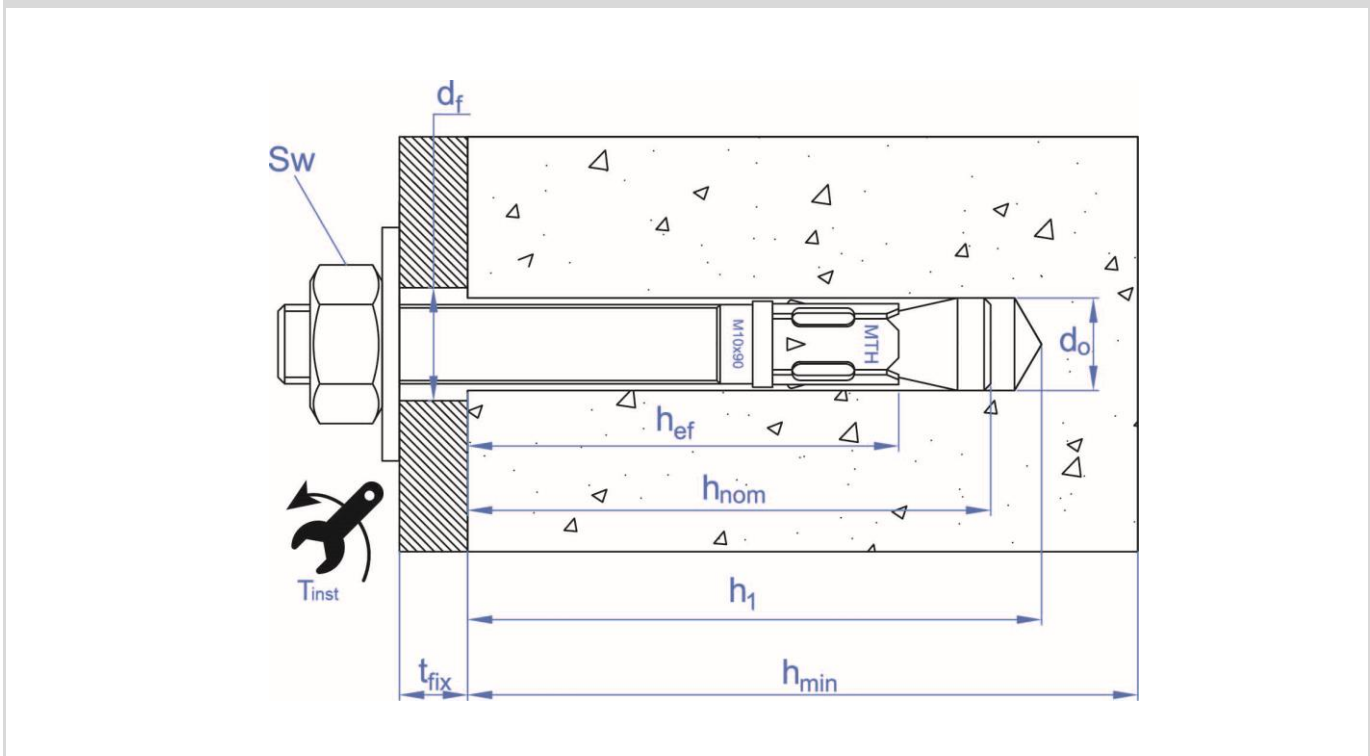

3.2. EINBAUKENNWERTE

Allgemeine Einbaukennwerte				Standard-Einbautiefe												Reduzierte Einbautiefe											
Familie	Artikelnr.	Größe / Buchstabe	Zulassung	Bohrungsdurchmesser	Bohrlochdurchmesser der zu befestigenden Bauteile	Einbaudrehmoment	Minimaler Achsabstand	Minimaler Abstand zum Rand	Minimale Betondicke	Bohrlochtiefe	Einbautiefe	Effektive Tiefe	Zu befestigende Dicke	Kritischer Achsabstand (Ausbruch)	Kritischer Abstand zum Rand (Ausbruch)	Kritischer Achsabstand (Spalten)	Kritischer Abstand zum Rand (Spalten)	Minimale Betondicke	Bohrlochtiefe	Einbautiefe	Effektive Tiefe	Zu befestigende Dicke	Kritischer Achsabstand (Ausbruch)	Kritischer Abstand zum Rand (Ausbruch)	Kritischer Achsabstand (Spalten)	Kritischer Abstand zum Rand (Spalten)	
[--]	[--]	[--]	ETA	d <sub>0</sub>	d <sub>f</sub>	T <sub>inst</sub>	S <sub>min</sub>	C <sub>min</sub>	h <sub>min</sub>	h <sub>1</sub>	h <sub>nom</sub>	h <sub>ef</sub>	t <sub>fix</sub>	S <sub>cr,N</sub>	C <sub>cr,N</sub>	S <sub>cr,sp</sub>	C <sub>cr,sp</sub>	h <sub>min</sub>	h <sub>1</sub>	h <sub>nom</sub>	h <sub>ef</sub>	t <sub>fix</sub>	S <sub>cr,N</sub>	C <sub>cr,N</sub>	S <sub>cr,sp</sub>	C <sub>cr,sp</sub>	
				[mm]	[mm]	[Nm]	[mm]	[mm]	[mm]	[mm]	[mm]	[mm]	[mm]	[mm]	[mm]	[mm]	[mm]	[mm]	[mm]	[mm]	[mm]	[mm]	[mm]	[mm]	[mm]	[mm]	[mm]
MTH	AH06060	M6 x 60 (B)	✓	6	7	7	35	35	100	55	49,5	40	2	120	60	160	80	--	--	--	--	--	--	--	--	--	--
	AH06070	M6 x 70 (C)	✓										--														
	AH06080	M6 x 80 (D)	✓										--														
	AH06090	M6 x 90 (E)	✓										--														
	AH06100	M6 x 100 (E)	✓										--														
	AH06110	M6 x 110 (F)	✓										--														
	AH06120	M6 x 120 (G)	✓										62														
	AH06130	M6 x 130 (H)	✓										72														
	AH06140	M6 x 140 (I)	✓										82														
	AH06150	M6 x 150 (I)	✓										92														
	AH06160	M6 x 160 (J)	✓										102														
	AH06170	M6 x 170 (K)	✓										112														
	AH06180	M6 x 180 (L)	✓	122																							
	AH08060	M8 x 60 (B)	✓	8	9	20	40	40	--	--	--	--	--	--	--	--	--	--	100	50	46,5	35	3	105	53	140	70
	AH08075	M8 x 75 (C)	✓						5																		
	AH08090	M8 x 90 (E)	✓						20																		
	AH08100	M8 x 100 (E)	✓						30																		
	AH08115	M8 x 115 (G)	✓						45																		
	AH08120	M8 x 120 (G)	✓						50																		
	AH08130	M8 x 130 (H)	✓						60																		
	AH08155	M8 x 155 (J)	✓						85																		
AH10070	M10 x 70 (C)	✓	10	12	35	50	50	--	--	--	--	--	--	--	--	--	--	100	60	53,5	42	3	126	63	168	84	
AH10080	M10 x 80 (D)	✓						13																			
AH10090	M10 x 90 (E)	✓						10																			
AH10100	M10 x 100 (E)	✓						20																			
AH10120	M10 x 120 (G)	✓						40																			
								110																			

## 3.2. EINBAUKENNWERTE

Allgemeine Einbaukennwerte									Standard-Einbautiefe								Reduzierte Einbautiefe																						
Familie	Artikelnr.	Größe / Buchstabe	Zulassung	Bohrungsdurchmesser	Bohrlochdurchmesser der zu befestigenden Bauteile	Einbaudrehmoment	Minimaler Achsabstand	Minimaler Abstand zum Rand	Minimale Betondecke	Bohrlochtiefe	Einbautiefe	Effektive Tiefe	Zu befestigende Dicke	Kritischer Achsabstand (Ausbruch)	Kritischer Abstand zum Rand (Ausbruch)	Kritischer Achsabstand (Spalten)	Kritischer Abstand zum Rand (Spalten)	Minimale Betondecke	Bohrlochtiefe	Einbautiefe	Effektive Tiefe	Zu befestigende Dicke	Kritischer Achsabstand (Ausbruch)	Kritischer Abstand zum Rand (Ausbruch)	Kritischer Achsabstand (Spalten)	Kritischer Abstand zum Rand (Spalten)													
[--]	[--]	[--]	ETA	d <sub>0</sub> [mm]	d <sub>r</sub> [mm]	T <sub>inst</sub> [Nm]	S <sub>min</sub> [mm]	C <sub>min</sub> [mm]	h <sub>min</sub> [mm]	h <sub>1</sub> [mm]	h <sub>nom</sub> [mm]	h <sub>ef</sub> [mm]	t <sub>fix</sub> [mm]	S <sub>cr,N</sub> [mm]	C <sub>cr,N</sub> [mm]	S <sub>cr,sp</sub> [mm]	C <sub>cr,sp</sub> [mm]	h <sub>min</sub> [mm]	h <sub>1</sub> [mm]	h <sub>nom</sub> [mm]	h <sub>ef</sub> [mm]	t <sub>fix</sub> [mm]	S <sub>cr,N</sub> [mm]	C <sub>cr,N</sub> [mm]	S <sub>cr,sp</sub> [mm]	C <sub>cr,sp</sub> [mm]													
MTH	AH10140	M10 x 140 (I)	✓	10	12	35	50	50	110	75	66,5	55	60	165	83	220	110	100	60	53,5	42	73	126	63	168	84													
	AH10150	M10 x 150 (I)	✓										70									83																	
	AH10160	M10 x 160 (J)	✓										80									93																	
	AH10170	M10 x 170 (K)	✓										90									103																	
	AH10210	M10 x 210 (N)	✓										130									143																	
	AH10230	M10 x 230 (P)	✓										150									163																	
	AH12090	M12 x 90 (E)	✓	12	14	60	70	70	--	--	--	--	--	--	--	--	--	100	70	62	50	13	150	75	200	100													
	AH12100	M12 x 100 (E)	✓						8	23																													
	AH12110	M12 x 110 (F)	✓						18	33																													
	AH12120	M12 x 120 (G)	✓						28	43																													
	AH12130	M12 x 130 (H)	✓						38	53																													
	AH12140	M12 x 140 (I)	✓						48	63																													
	AH12160	M12 x 160 (J)	✓						68	83																													
	AH12180	M12 x 180 (L)	✓						88	103																													
	AH12200	M12 x 200 (M)	✓						108	123																													
	AH12220	M12 x 220 (O)	✓						128	143																													
	AH12250	M12 x 250 (Q)	✓						158	173																													
	AH14120	M14 x 120 (G)	✓						14	16	90	80	80	150	100	91	75					12					225	113	300	150	--	--	--	--	--	--	--	--	--
	AH14145	M14 x 145 (I)	✓																			37													--				
	AH14170	M14 x 170 (K)	✓																			62													--				
AH14220	M14 x 220 (O)	✓	112	--																																			
AH14250	M14 x 250 (Q)	✓	142	--																																			

3.2. EINBAUKENNWERTE

Allgemeine Einbaukennwerte									Standard-Einbautiefe								Reduzierte Einbautiefe																											
Familie	Artikelnr.	Größe / Buchstabe	Zulassung	Bohrungsdurchmesser	Bohrlochdurchmesser der zu befestigenden	Einbaudrehmoment	Minimaler Achsabstand	Minimaler Abstand zum Rand	Minimale Betondicke	Bohrlochtiefe	Einbautiefe	Effektive Tiefe	Zu befestigende Dicke	Kritischer Achsabstand (Ausbruch)	Kritischer Abstand zum Rand (Ausbruch)	Kritischer Achsabstand (Spalten)	Kritischer Abstand zum Rand (Spalten)	Minimale Betondicke	Bohrlochtiefe	Einbautiefe	Effektive Tiefe	Zu befestigende Dicke	Kritischer Achsabstand (Ausbruch)	Kritischer Abstand zum Rand (Ausbruch)	Kritischer Achsabstand (Spalten)	Kritischer Abstand zum Rand (Spalten)																		
[--]	[--]	[--]	ETA	d <sub>0</sub> [mm]	d <sub>f</sub> [mm]	T <sub>inst</sub> [Nm]	S <sub>min</sub> [mm]	C <sub>min</sub> [mm]	h <sub>min</sub> [mm]	h <sub>1</sub> [mm]	h <sub>nom</sub> [mm]	h <sub>ef</sub> [mm]	t <sub>fix</sub> [mm]	S <sub>cr,N</sub> [mm]	C <sub>cr,N</sub> [mm]	S <sub>cr,sp</sub> [mm]	C <sub>cr,sp</sub> [mm]	h <sub>min</sub> [mm]	h <sub>1</sub> [mm]	h <sub>nom</sub> [mm]	h <sub>ef</sub> [mm]	t <sub>fix</sub> [mm]	S <sub>cr,N</sub> [mm]	C <sub>cr,N</sub> [mm]	S <sub>cr,sp</sub> [mm]	C <sub>cr,sp</sub> [mm]																		
MTH	AH16125	M16 x 125 (G)	✓	16	18	120	90	90	168	110	103,5	84	3	252	126	280	140	130	90	84,5	65	22	195	98	260	130																		
	AH16145	M16 x 145 (I)	✓										23									42																						
	AH16170	M16 x 170 (K)	✓										48									67																						
	AH16220	M16 x 220 (O)	✓										98									117																						
	AH16250	M16 x 250 (Q)	✓										128									147																						
	AH16280	M16 x 280 (S)	✓										158									177																						
	AH20170	M20 x 170 (K)	✓										23									49																						
	AH20220	M20 x 220 (O)	✓										73									99																						
AH20270	M20 x 270 (S)	✓	123	149																																								
MTH-AZ	MI06045	M6 x 45 (A)	✗	6	7	7	50	50	100	55	49,5	40	--	120	60	160	80	--	--	--	--	1	75	38	160	80																		
	MI06060	M6 x 60 (B)	✓										2									--																						
	MI06080	M6 x 80 (D)	✓										22									--																						
	MI06120	M6 x 120 (G)	✓										62									--																						
	MI06140	M6 x 140 (I)	✓										82									--																						
	MI06160	M6 x 160 (J)	✓										102									--																						
	MI06170	M6 x 170 (K)	✓										112									--																						
	MI06180	M6 x 180 (L)	✓										122									--																						
	MI08050	M8 x 50 (A)	✗										--									100					65	59,5	48	--	144	72	192	96	100	50	46,5	35	35	4	105	53	140	70
	MI08075	M8 x 75 (C)	✓										5																	18														
	MI08090	M8 x 90 (E)	✓										20																	33														
	MI08115	M8 x 115 (G)	✓										45																	58														
	MI10070	M10 x 70 (C)	✓										--									110					75	66,5	55	--	165	83	220	110	100	60	53,5	42	42	3	126	63	168	84
	MI10090	M10 x 90 (E)	✓										10																	23														
	MI10120	M10 x 120 (G)	✓										40																	53														
MI10150	M10 x 150 (I)	✓	70	83																																								

## 3.2. EINBAUKENNWERTE

Allgemeine Einbaukennwerte									Standard-Einbautiefe								Reduzierte Einbautiefe											
Familie	Artikelnr.	Größe / Buchstabe	Zulassung	Bohrungsdurchmesser	Bohrlochdurchmesser der zu befestigenden	Einbaudrehmoment	Minimaler Achsabstand	Minimaler Abstand zum Rand	Minimale Betondicke	Bohrlochtiefe	Einbautiefe	Effektive Tiefe	Zu befestigende Dicke	Kritischer Achsabstand (Ausbruch)	Kritischer Abstand zum Rand (Ausbruch)	Kritischer Achsabstand (Spalten)	Kritischer Abstand zum Rand (Spalten)	Minimale Betondicke	Bohrlochtiefe	Einbautiefe	Effektive Tiefe	Zu befestigende Dicke	Kritischer Achsabstand (Ausbruch)	Kritischer Abstand zum Rand (Ausbruch)	Kritischer Achsabstand (Spalten)	Kritischer Abstand zum Rand (Spalten)		
				$d_0$	$d_f$	$T_{inst}$	$S_{min}$	$C_{min}$	$h_{min}$	$h_1$	$h_{nom}$	$h_{ef}$	$t_{fix}$	$S_{cr,N}$	$C_{cr,N}$	$S_{cr,sp}$	$C_{cr,sp}$	$h_{min}$	$h_1$	$h_{nom}$	$h_{ef}$	$t_{fix}$	$S_{cr,N}$	$C_{cr,N}$	$S_{cr,sp}$	$C_{cr,sp}$		
[--]	[--]	[--]	ETA	[mm]	[mm]	[Nm]	[mm]	[mm]	[mm]	[mm]	[mm]	[mm]	[mm]	[mm]	[mm]	[mm]	[mm]	[mm]	[mm]	[mm]	[mm]	[mm]	[mm]	[mm]	[mm]	[mm]		
MTH-A2	MI12075	M12 x 75 (C)	[x]						--	--	--	--	--	--	--	--	--	100	60	55	43	5	129	65	200	100		
	MI12090	M12 x 90 (D)	✓						--	--	--	--	--	--	--	--	--					13						
	MI12110	M12 x 110 (F)	✓	12	14	60	85	85														33	150	75	200	100		
	MI12140	M12 x 140 (I)	✓						130	85	77	65		18	195	98	260	130	100	70	62	50						
													48									63						
	MI16090	M16 x 90 (D)	[x]						--	--	--	--	--	--	--	--	--	--	100	75	69	49	4	147	74	280	140	
	MI16145	M16 x 145 (I)	✓	16	18	120	110	110						23	252	126	336	168	--	--	--	--	--	--	--	--		
	MI16170	M16 x 170 (K)	✓						168	110	103,5	84		48					--	--	--	--	--	--	--	--		
	MI20120	M20 x 120 (G)	[x]						--	--	--	--	--	--	--	--	--	--	145	105	93	71	5	213	107	360	180	
MI20170	M20 x 170 (K)	✓	20	22	240	135	135						23	309	155	412	200	--	--	--	--	--	--	--	--			
MI20220	M20 x 220 (O)	✓						206	135	125	103		73					--	--	--	--	--	--	--	--			
MTH-A4	MIA406045	M6 x 45 (A)	[x]						--	--	--	--	--	--	--	--	--	100	40	35	25	1	75	38	160	80		
	MIA406060	M6 x 60 (B)	✓	6	7	7	50	50					2	120	60	160	80	--	--	--	--	--	--	--	--	--		
	MIA406080	M6 x 80 (D)	✓						100	55	49,5	40		22				--	--	--	--	--	--	--	--	--		
	MIA408050	M8 x 50 (A)	[x]						--	--	--	--	--	--	--	--	--	--	100	40	35	23	4	69	35	140	70	
	MIA408075	M8 x 75 (C)	✓																			8						
	MIA408090	M8 x 90 (E)	✓	8	9	20	65	65	100	65	59,5	48		20	144	72	192	96	100	50	46,5	35		23	105	53	140	70
	MIA408115	M8 x 115 (G)	✓											45								58						
	MIA410070	M10 x 70 (C)	✓						--	--	--	--	--	--	--	--	--	--					3					
	MIA410090	M10 x 90 (E)	✓											10								23						
	MIA410120	M10 x 120 (G)	✓	10	12	35	70	70	110	75	66,5	55		40	165	83	220	110	100	60	53,5	42		53	126	63	168	84
	MIA410150	M10 x 150 (I)	✓											70								83						
	MIA412075	M12 x 75 (C)	[x]						--	--	--	--	--	--	--	--	--	--	100	60	55	43	5	129	65	200	100	
	MIA412090	M12 x 90 (D)	✓						--	--	--	--	--	--	--	--	--	--					13					
	MIA412110	M12 x 110 (F)	✓	12	14	60	85	85						18	195	98	260	130	100	70	62	50		33	150	75	200	100
MIA412140	M12 x 140 (I)	✓						130	85	77	65		48								63							

3.2. EINBAUKENNWERTE

Allgemeine Einbaukennwerte				Standard-Einbautiefe												Reduzierte Einbautiefe														
Familie	Artikelnr.	Größe / Buchstabe	Zulassung	Bohrungsdurchmesser	Bohrlochdurchmesser der zu befestigenden Bauteile	Einbaudrehmoment	Minimaler Achsabstand	Minimaler Abstand zum Rand	Minimale Betondicke	Bohrlochtiefe	Einbautiefe	Effektive Tiefe	Zu befestigende Dicke	Kritischer Achsabstand (Ausbruch)	Kritischer Abstand zum Rand (Ausbruch)	Kritischer Achsabstand (Spalten)	Kritischer Abstand zum Rand (Spalten)	Minimale Betondicke	Bohrlochtiefe	Einbautiefe	Effektive Tiefe	Zu befestigende Dicke	Kritischer Achsabstand (Ausbruch)	Kritischer Abstand zum Rand (Ausbruch)	Kritischer Achsabstand (Spalten)	Kritischer Abstand zum Rand (Spalten)				
			ETA																								$d_0$ [mm]	$d_f$ [mm]	$T_{inst}$ [Nm]	$S_{min}$ [mm]
MTH-A4	MIA416090	M16 x 90 (D)	[x]	16	18	120	110	110	--	--	--	--	--	--	--	--	--	100	75	69	49	4	147	74	280	140				
	MIA416145	M16 x 145 (I)	✓						168	110	103,5	84	23	252	126	336	168	--	--	--	--	--	--	--	--	--	--	--	--	--
	MIA416170	M16 x 170 (K)	✓						48	--	--	--	--	--	--	--	--	--	--	--	--	--	145	105	93	71	5	213	107	360
	MIA420120	M20 x 120 (G)	[x]	20	22	240	135	135	--	--	--	--	--	--	--	--	--	--	145	105	93	71	5	213	107	360	180			
	MIA420170	M20 x 170 (K)	✓						23	309	155	412	206	--	--	--	--	--	--	--	--	--	--	--	--	--	--	--	--	--
MIA420220	M20 x 220 (O)	✓	73	--	--	--	--	--	--	--	--	--	--	--	--	--	--	--	--	--	--	--	--	--	--	--				

## 3.2. EINBAUKENNWERTE

Allgemeine Einbaukennwerte				Standard-Einbautiefe													Reduzierte Einbautiefe																																
Familie	Artikelnr.	Größe / Buchstabe	Zulassung	Bohrungsdurchmesser	Bohrlochdurchmesser der zu befestigenden	Einbaudrehmoment	Minimaler Achsabstand	Minimaler Abstand zum Rand	Minimale Betondeicke	Bohrlochtiefe	Einbautiefe	Effektive Tiefe	Zu befestigende Dicke	Kritischer Achsabstand (Ausbruch)	Kritischer Abstand zum Rand (Ausbruch)	Kritischer Achsabstand (Spalten)	Kritischer Abstand zum Rand (Spalten)	Minimale Betondeicke	Bohrlochtiefe	Einbautiefe	Effektive Tiefe	Zu befestigende Dicke	Kritischer Achsabstand (Ausbruch)	Kritischer Abstand zum Rand (Ausbruch)	Kritischer Achsabstand (Spalten)	Kritischer Abstand zum Rand (Spalten)																							
[--]	[--]	[--]	ETA	d <sub>0</sub> [mm]	d <sub>f</sub> [mm]	T <sub>inst</sub> [Nm]	S <sub>min</sub> [mm]	C <sub>min</sub> [mm]	h <sub>min</sub> [mm]	h <sub>1</sub> [mm]	h <sub>nom</sub> [mm]	h <sub>ef</sub> [mm]	t <sub>fix</sub> [mm]	S <sub>cr,N</sub> [mm]	C <sub>cr,N</sub> [mm]	S <sub>cr,sp</sub> [mm]	C <sub>cr,sp</sub> [mm]	h <sub>min</sub> [mm]	h <sub>1</sub> [mm]	h <sub>nom</sub> [mm]	h <sub>ef</sub> [mm]	t <sub>fix</sub> [mm]	S <sub>cr,N</sub> [mm]	C <sub>cr,N</sub> [mm]	S <sub>cr,sp</sub> [mm]	C <sub>cr,sp</sub> [mm]																							
MTH-AT	AHAT06060	M6 x 60 (B)	✓	6	7	7	35	35	100	55	49,5	40	2	120	60	160	80	--	--	--	--	--	--	--	--	--	--																						
	AHAT06080	M6 x 80 (D)	✓										22									--						--	--																				
	AHAT06100	M6 x 100 (E)	✓										42									--						--	--																				
	AHAT08060	M8 x 60 (B)	✓	8	9	20	40	40	100	65	59,5	48	--	--	144	72	192	96	100	50	46,5	35	3	105	53	140	70																						
	AHAT08075	M8 x 75 (C)	✓																				5					18																					
	AHAT08090	M8 x 90 (E)	✓																				20					33																					
	AHAT08115	M8 x 115 (G)	✓																				45					58																					
	AHAT08120	M8 x 120 (G)	✓																				50					63																					
	AHAT08130	M8 x 130 (H)	✓																				60					73																					
	AHAT08155	M8 x 155 (J)	✓																				85					98																					
	AHAT10070	M10 x 70 (C)	✓																				--					--	--	--	--	--	--	--	--	--	--	--	--	--	--	--	--	--	3	--	--	--	--
	AHAT10080	M10 x 80 (D)	✓	--	--	--	--	--	--	--	--	--	--	--	--	--	--	--	--	--	--	--	13	--	--	--	--																						
	AHAT10090	M10 x 90 (E)	✓	10	12	35	50	50	110	75	66,5	55	--	10	165	83	220	110	100	60	53,5	42	23	126	63	168	84																						
	AHAT10100	M10 x 100 (E)	✓																				20					33																					
	AHAT10120	M10 x 120 (G)	✓																				40					53																					
	AHAT10140	M10 x 140 (I)	✓																				60					73																					
	AHAT10150	M10 x 150 (I)	✓																				70					83																					
	AHAT10160	M10 x 160 (J)	✓																				80					93																					
	AHAT10170	M10 x 170 (K)	✓																				90					103																					
	AHAT10210	M10 x 210 (N)	✓																				130					143																					
	AHAT12090	M12 x 90 (E)	✓																				--					--	--	--	--	--	--	--	--	--	--	--	--	--	--	--	--	--	13	--	--	--	--
	AHAT12100	M12 x 100 (E)	✓																				8					23																					
	AHAT12110	M12 x 110 (F)	✓	18	33																																												
	AHAT12130	M12 x 130 (H)	✓	38	53																																												
	AHAT12140	M12 x 140 (I)	✓	48	63																																												
	AHAT12160	M12 x 160 (J)	✓	68	83																																												
	AHAT12180	M12 x 180 (L)	✓	88	103																																												
	AHAT12200	M12 x 200 (M)	✓	108	123																																												
AHAT12220	M12 x 220 (O)	✓	128	143																																													
AHAT12250	M12 x 250 (Q)	✓	158	173																																													



## 4. EINBAUVERFAHREN

### 4.1 EINBAU IN BETON

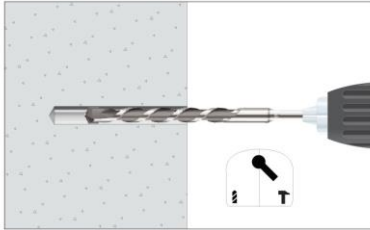

#### 1. BOHRLOCH ERSTELLEN

Sicherstellen, dass der Beton ausreichend verdichtet ist und keine bedeutende Porenbildung aufweist.

Verwendbar mit trockenen, feuchten oder mit Wasser gefüllten Bohrlöchern.

Bohrlocherstellung mittels Schlag- oder Hammerbohren.

Das Bohrloch mit dem spezifizierten Durchmesser und der spezifizierten Tiefe erstellen.



#### 2. AUSBLASEN UND REINIGEN

Das Bohrloch von Staubresten und Bohrungsrückständen reinigen (siehe Grafik).

Hierzu eine Luftpumpe und eine Bürste verwenden.

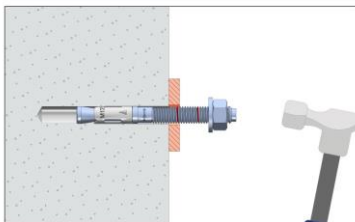

#### 3. EINBAUEN

Die Verankerung einbringen, bis Tiefenmarkierung bündig mit der Oberfläche des Baustoffs abschließt.

Bei Bedarf einen Hammer verwenden. Alternativ kann auch das Setzwerkzeug DOMTA verwendet werden.

Der Einbau kann entweder über das zu befestigende Material oder vor dem Setzen des Materials erfolgen.

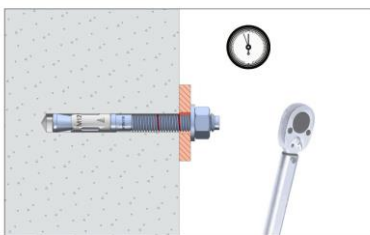

#### 4. FESTZIEHEN

Mit dem in der Tabelle der Einbaudaten angegebenen Nenn-Anzugsdrehmoment festziehen.

Einen Drehmomentschlüssel verwenden, um einen korrekten Einbau zu gewährleisten.

**5. TRAGFÄHIGKEIT**

Die Tragfähigkeitswerte in Beton C20/25 für eine einzelne Verankerung ohne Einwirkung von Rand- oder Achsabstand-Effekten werden in der nachfolgenden Tabelle angegeben:

**5.1 CHARAKTERISTISCHE FESTIGKEIT [kN]**

Allgemeine Parameter				Standard-Einbautiefe		Reduzierte Einbautiefe	
Familie	Artikelnr.	Größe	Zulassung	Zuglast	Querlast	Zuglast	Querlast
				N <sub>Rk</sub>	V <sub>Rk</sub>	N <sub>Rk</sub>	V <sub>Rk</sub>
MTH	AH06060	M6 x 60	✓	<u>7,40</u>	<u>5,10</u>	--	--
	AH06070	M6 x 70	✓				
	AH06080	M6 x 80	✓				
	AH06090	M6 x 90	✓				
	AH06100	M6 x 100	✓				
	AH06110	M6 x 110	✓				
	AH06120	M6 x 120	✓				
	AH06130	M6 x 130	✓				
	AH06140	M6 x 140	✓				
	AH06150	M6 x 150	✓				
	AH06160	M6 x 160	✓				
	AH06170	M6 x 170	✓				
	AH06180	M6 x 180	✓				
	AH08060	M8 x 60	✓	--	--	10,00	<b>10,19</b>
	AH08075	M8 x 75	✓	<u>13,00</u>	<u>9,30</u>	10,00	<b>10,19</b>
	AH08090	M8 x 90	✓				
	AH08100	M8 x 100	✓				
	AH08115	M8 x 115	✓				
	AH08120	M8 x 120	✓				
	AH08130	M8 x 130	✓				
	AH08155	M8 x 155	✓	--	--	<b>13,39</b>	<b>13,39</b>
	AH10070	M10 x 70	✓				
	AH10080	M10 x 80	✓	19,00	<u>14,70</u>	<b>13,39</b>	<b>13,39</b>
	AH10090	M10 x 90	✓				
	AH10100	M10 x 100	✓				
	AH10120	M10 x 120	✓				
	AH10140	M10 x 140	✓				
	AH10150	M10 x 150	✓				
	AH10160	M10 x 160	✓				
	AH10170	M10 x 170	✓				
	AH10210	M10 x 210	✓				
	AH10230	M10 x 230	✓				
AH12090	M12 x 90	✓	--	--	<b>17,39</b>	<b>17,39</b>	
AH12100	M12 x 100	✓	<b>25,78</b>	<u>20,60</u>	<b>17,39</b>	<b>17,39</b>	
AH12110	M12 x 110	✓					
AH12120	M12 x 120	✓					
AH12130	M12 x 130	✓					
AH12140	M12 x 140	✓					
AH12160	M12 x 160	✓					
AH12180	M12 x 180	✓					
AH12200	M12 x 200	✓					
AH12220	M12 x 220	✓					
AH12250	M12 x 250	✓					
AH14120	M14 x 120	✓	<b>31,95</b>	<u>28,10</u>	--	--	
AH14145	M14 x 145	✓					
AH14170	M14 x 170	✓					
AH14220	M14 x 220	✓					
AH14250	M14 x 250	✓					

Allgemeine Parameter				Standard-Einbautiefe		Reduzierte Einbautiefe					
Familie	Artikelnr.	Größe	Zulassung	Zuglast	Querlast	Zuglast	Querlast				
				N <sub>Rk</sub>	V <sub>Rk</sub>	N <sub>Rk</sub>	V <sub>Rk</sub>				
MTH	AH16125	M16 x 125	✓	<b>38,87</b>	<u>38,40</u>	<b>25,78</b>	<u>38,40</u>				
	AH16145	M16 x 145	✓								
	AH16170	M16 x 170	✓								
	AH16220	M16 x 220	✓								
	AH16250	M16 x 250	✓								
	AH16280	M16 x 280	✓								
	AH20170	M20 x 170	✓								
	AH20220	M20 x 220	✓								
AH20270	M20 x 270	✓	<b>51,42</b>	<u>56,30</u>	<b>31,95</b>	<b>63,90</b>					
MTH-A2	MI06045	M6 x 45	[x]	--	--	<b>6,15</b>	<u>6,00</u>				
	MI06060	M6 x 60	✓	<u>10,10</u>	<u>6,00</u>	--	--				
	MI06080	M6 x 80	✓								
	MI06120	M6 x 120	✓								
	MI06140	M6 x 140	✓								
	MI06160	M6 x 160	✓								
	MI06170	M6 x 170	✓								
	MI06180	M6 x 180	✓								
	MI08050	M8 x 50	[x]					--	--	<b>5,43</b>	<b>5,43</b>
	MI08075	M8 x 75	✓	12,00	<u>10,90</u>	9,00	<b>10,19</b>				
	MI08090	M8 x 90	✓								
	MI08115	M8 x 115	✓								
	MI10070	M10 x 70	✓								
	MI10090	M10 x 90	✓	16,00	<u>17,40</u>	12,00	<b>13,39</b>				
	MI10120	M10 x 120	✓								
	MI10150	M10 x 150	✓								
	MI12075	M12 x 75	[x]					--	--	<b>13,87</b>	<b>13,87</b>
	MI12090	M12 x 90	✓	--	--	16,00	<b>17,39</b>				
	MI12110	M12 x 110	✓	25,00	<u>25,20</u>						
	MI12140	M12 x 140	✓								
	MI16090	M16 x 90	[x]	--	--	<b>16,87</b>	<b>16,87</b>				
	MI16145	M16 x 145	✓	35,00	<u>47,10</u>	--	--				
	MI16170	M16 x 170	✓								
	MI20120	M20 x 120	[x]	--	--	<b>29,43</b>	<b>45,82</b>				
MI20170	M20 x 170	✓	50,00	<u>73,50</u>	--	--					
MI20220	M20 x 220	✓									
MTH-A4	MIA406045	M6 x 45	[x]	--	--	<b>6,15</b>	<u>6,00</u>				
	MIA406060	M6 x 60	✓	<u>10,10</u>	<u>6,00</u>	--	--				
	MIA406080	M6 x 80	✓								
	MIA408050	M8 x 50	[x]					--	--	<b>5,43</b>	<b>5,43</b>
	MIA408075	M8 x 75	✓					12,00	<u>10,90</u>	9,00	<b>10,19</b>
	MIA408090	M8 x 90	✓								
	MIA408115	M8 x 115	✓								
	MIA410070	M10 x 70	✓								
	MIA410090	M10 x 90	✓					16,00	<u>17,40</u>	12,00	<b>13,39</b>
	MIA410120	M10 x 120	✓								
	MIA410150	M10 x 150	✓								
	MIA412075	M12 x 75	[x]	--	--	<b>13,87</b>	<b>13,87</b>				
	MIA412090	M12 x 90	✓	--	--	16,00	<b>17,39</b>				
	MIA412110	M12 x 110	✓	25,00	<u>25,20</u>						
	MIA412140	M12 x 140	✓								
	MIA416090	M16 x 90	[x]	--	--	<b>16,87</b>	<b>16,87</b>				
	MIA416145	M16 x 145	✓	35,00	<u>47,10</u>	--	--				
	MIA416170	M16 x 170	✓								
	MIA420120	M20 x 120	[x]	--	--	<b>29,43</b>	<b>58,86</b>				
	MIA420170	M20 x 170	✓	50,00	<u>73,50</u>	--	--				
MIA420220	M20 x 220	✓									

Allgemeine Parameter				Standard-Einbautiefe		Reduzierte Einbautiefe	
Familie	Artikelnr.	Größe	Zulassung	Tracción	Cortadura	Tracción	Cortadura
				N <sub>Rk</sub>	V <sub>Rk</sub>	N <sub>Rk</sub>	V <sub>Rk</sub>
MTH-AT	AHAT06060	M6 x 60	✓				
	AHAT06080	M6 x 80	✓	<u>7,40</u>	<u>5,10</u>	--	--
	AHAT06100	M6 x 100	✓				
	AHAT08060	M8 x 60	✓	--	--	10,00	<b>10,19</b>
	AHAT08075	M8 x 75	✓				
	AHAT08090	M8 x 90	✓				
	AHAT08100	M8 x 100	✓				
	AHAT08115	M8 x 115	✓	<u>13,00</u>	<u>9,30</u>	10,00	<b>10,19</b>
	AHAT08130	M8 x 130	✓				
	AHAT08155	M8 x 155	✓				
	AHAT10070	M10 x 70	✓				
	AHAT10080	M10 x 80	✓	--	--	<b>13,39</b>	<b>13,39</b>
	AHAT10090	M10 x 90	✓				
	AHAT10100	M10 x 100	✓				
	AHAT10120	M10 x 120	✓				
	AHAT10140	M10 x 140	✓	19,00	<u>14,70</u>	<b>13,39</b>	<b>13,39</b>
	AHAT10150	M10 x 150	✓				
	AHAT10160	M10 x 160	✓				
	AHAT10170	M10 x 170	✓				
	AHAT10210	M10 x 210	✓				
	AHAT12090	M12 x 90	✓	--	--	<b>17,39</b>	<b>17,39</b>
	AHAT12100	M12 x 100	✓				
	AHAT12110	M12 x 110	✓				
	AHAT12130	M12 x 130	✓				
	AHAT12140	M12 x 140	✓				
	AHAT12160	M12 x 160	✓	<b>25,78</b>	<u>20,60</u>	<b>17,39</b>	<b>17,39</b>
	AHAT12180	M12 x 180	✓				
	AHAT12200	M12 x 200	✓				
	AHAT12220	M12 x 220	✓				
	AHAT12250	M12 x 250	✓				
AHAT16125	M16 x 125	✓					
AHAT16145	M16 x 145	✓					
AHAT16170	M16 x 170	✓	<b>37,87</b>	<u>38,40</u>	<b>25,78</b>	<u>38,40</u>	
AHAT16220	M16 x 220	✓					
AHAT16250	M16 x 250	✓					
AHAT16280	M16 x 280	✓					
AHAT20170	M20 x 170	✓					
AHAT20220	M20 x 220	✓	<b>51,42</b>	<u>56,30</u>	<b>31,95</b>	<b>63,90</b>	
AHAT20270	M20 x 270	✓					

1 kN ≈ 100 kg

Unterstrichene und kursiv gedruckte Werte geben das Stahlversagen an; die **fett** gedruckten Werte geben das Versagen durch Betonausbruch und die restlichen das Versagen durch Herausziehen an.

5.2 BEMESSUNGSWERTE DER FESTIGKEIT [kN]

Allgemeine Parameter				Standard-Einbautiefe		Reduzierte Einbautiefe	
Familie	Artikelnr.	Größe	Zulassung	Zuglast	Querlast	Zuglast	Querlast
				N <sub>Rd</sub>	V <sub>Rd</sub>	N <sub>Rd</sub>	V <sub>Rd</sub>
MTH	AH06060	M6 x 60	✓	<u>5,29</u>	<u>4,08</u>	--	--
	AH06070	M6 x 70	✓				
	AH06080	M6 x 80	✓				
	AH06090	M6 x 90	✓				
	AH06100	M6 x 100	✓				
	AH06110	M6 x 110	✓				
	AH06120	M6 x 120	✓				
	AH06130	M6 x 130	✓				
	AH06140	M6 x 140	✓				
	AH06150	M6 x 150	✓				
	AH06160	M6 x 160	✓				
	AH06170	M6 x 170	✓				
	AH06180	M6 x 180	✓				
	AH08060	M8 x 60	✓	--	--	6,67	6,79
	AH08075	M8 x 75	✓	<u>9,29</u>	<u>7,44</u>	6,67	6,79
	AH08090	M8 x 90	✓				
	AH08100	M8 x 100	✓				
	AH08115	M8 x 115	✓				
	AH08120	M8 x 120	✓				
	AH08130	M8 x 130	✓				
	AH08155	M8 x 155	✓				
	AH10070	M10 x 70	✓	--	--	8,93	8,93
	AH10080	M10 x 80	✓	12,67	<u>11,76</u>	8,93	8,93
	AH10090	M10 x 90	✓				
	AH10100	M10 x 100	✓				
	AH10120	M10 x 120	✓				
	AH10140	M10 x 140	✓				
	AH10150	M10 x 150	✓				
	AH10160	M10 x 160	✓				
	AH10170	M10 x 170	✓				
	AH10210	M10 x 210	✓				
	AH10230	M10 x 230	✓				
	AH12090	M12 x 90	✓	--	--	11,60	11,60
	AH12100	M12 x 100	✓	17,19	<u>16,48</u>	11,60	11,60
	AH12110	M12 x 110	✓				
AH12120	M12 x 120	✓					
AH12130	M12 x 130	✓					
AH12140	M12 x 140	✓					
AH12160	M12 x 160	✓					
AH12180	M12 x 180	✓					
AH12200	M12 x 200	✓					
AH12220	M12 x 220	✓					
AH12250	M12 x 250	✓					
AH14120	M14 x 120	✓	21,30	<u>22,48</u>	--	--	
AH14145	M14 x 145	✓					
AH14170	M14 x 170	✓					
AH14220	M14 x 220	✓					
AH14250	M14 x 250	✓					

Allgemeine Parameter				Standard-Einbautiefe		Reduzierte Einbautiefe					
Familie	Artikelnr.	Größe	Zulassung	Zuglast	Querlast	Zuglast	Querlast				
				N <sub>Rd</sub>	V <sub>Rd</sub>	N <sub>Rd</sub>	V <sub>Rd</sub>				
MTH	AH16125	M16 x 125	✓	<b>25,25</b>	<u>30,72</u>	<b>17,19</b>	<u>30,72</u>				
	AH16145	M16 x 145	✓								
	AH16170	M16 x 170	✓								
	AH16220	M16 x 220	✓								
	AH16250	M16 x 250	✓	<b>34,28</b>	<u>45,04</u>	<b>21,30</b>	<b>42,60</b>				
	AH16280	M16 x 280	✓								
	AH20170	M20 x 170	✓								
	AH20220	M20 x 220	✓								
AH20270	M20 x 270	✓									
MTH-A2	MI06045	M6 x 45	[x]	--	--	<b>4,10</b>	<u>3,95</u>				
	MI06060	M6 x 60	✓	<u>6,01</u>	<u>3,95</u>	--	--				
	MI06080	M6 x 80	✓								
	MI06120	M6 x 120	✓								
	MI06140	M6 x 140	✓								
	MI06160	M6 x 160	✓								
	MI06170	M6 x 170	✓								
	MI06180	M6 x 180	✓	--	--	<b>3,01</b>	<b>3,62</b>				
	MI08050	M8 x 50	[x]	8,00	<u>7,15</u>	5,00	<b>6,79</b>				
	MI08075	M8 x 75	✓								
	MI08090	M8 x 90	✓								
	MI08115	M8 x 115	✓	--	--	6,67	<b>8,93</b>				
	MI10070	M10 x 70	✓								
	MI10090	M10 x 90	✓								
	MI10120	M10 x 120	✓	8,89	<u>11,45</u>	8,89	<b>11,60</b>				
	MI10150	M10 x 150	✓								
	MI12075	M12 x 75	[x]	--	--	<b>7,71</b>	<b>9,25</b>				
	MI12090	M12 x 90	✓	--	--	8,89	<b>11,60</b>				
	MI12110	M12 x 110	✓								
	MI12140	M12 x 140	✓	13,89	<u>16,58</u>	<b>9,37</b>	<b>11,25</b>				
	MI16090	M16 x 90	[x]	--	--						
	MI16145	M16 x 145	✓	19,44	<u>30,99</u>	--	--				
	MI16170	M16 x 170	✓	--	--	<b>16,35</b>	<b>39,24</b>				
	MI20120	M20 x 120	[x]								
MI20170	M20 x 170	✓	27,78	<u>48,36</u>	--	--					
MI20220	M20 x 220	✓									
MTH-A4	MIA406045	M6 x 45	[x]	--	--	<b>4,10</b>	<u>3,95</u>				
	MIA406060	M6 x 60	✓	<u>6,01</u>	<u>3,95</u>	--	--				
	MIA406080	M6 x 80	✓								
	MIA408050	M8 x 50	[x]					--	--	<b>3,01</b>	<b>3,62</b>
	MIA408075	M8 x 75	✓					8,00	<u>7,17</u>	5,00	<b>6,79</b>
	MIA408090	M8 x 90	✓								
	MIA408115	M8 x 115	✓								
	MIA410070	M10 x 70	✓	--	--	6,67	<b>8,93</b>				
	MIA410090	M10 x 90	✓								
	MIA410120	M10 x 120	✓								
	MIA410150	M10 x 150	✓	8,89	<u>11,45</u>	8,89	<b>11,60</b>				
	MIA412075	M12 x 75	[x]	--	--			<b>7,71</b>	<b>9,25</b>		
	MIA412090	M12 x 90	✓	--	--	8,89	<b>11,60</b>				
	MIA412110	M12 x 110	✓								
	MIA412140	M12 x 140	✓	13,89	<u>16,58</u>	<b>9,37</b>	<b>11,25</b>				
	MIA416090	M16 x 90	[x]	--	--						
	MIA416145	M16 x 145	✓	19,44	<u>30,99</u>	--	--				
	MIA416170	M16 x 170	✓	--	--	<b>16,35</b>	<b>39,24</b>				
	MIA420120	M20 x 120	[x]								
	MIA420170	M20 x 170	✓	27,78	<u>48,36</u>	--	--				
MIA420220	M20 x 220	✓									

Allgemeine Parameter				Standard-Einbautiefe		Reduzierte Einbautiefe	
Familie	Artikelnr.	Größe	Zulassung	Zuglast	Querlast	Zuglast	Querlast
				N <sub>Rd</sub>	V <sub>Rd</sub>	N <sub>Rd</sub>	V <sub>Rd</sub>
MTH-AT	AHAT06060	M6 x 60	✓				
	AHAT06080	M6 x 80	✓	<u>5,29</u>	<u>4,08</u>	--	--
	AHAT06100	M6 x 100	✓				
	AHAT08060	M8 x 60	✓	--	--	6,67	<b>6,79</b>
	AHAT08075	M8 x 75	✓				
	AHAT08090	M8 x 90	✓				
	AHAT08100	M8 x 100	✓				
	AHAT08115	M8 x 115	✓	<u>9,29</u>	<u>7,44</u>	6,67	<b>6,79</b>
	AHAT08130	M8 x 130	✓				
	AHAT08155	M8 x 155	✓				
	AHAT10070	M10 x 70	✓				
	AHAT10080	M10 x 80	✓	--	--	<b>8,93</b>	<b>8,93</b>
	AHAT10090	M10 x 90	✓				
	AHAT10100	M10 x 100	✓				
	AHAT10120	M10 x 120	✓				
	AHAT10140	M10 x 140	✓				
	AHAT10150	M10 x 150	✓	12,67	<u>11,76</u>	<b>8,93</b>	<b>8,93</b>
	AHAT10160	M10 x 160	✓				
	AHAT10170	M10 x 170	✓				
	AHAT10210	M10 x 210	✓				
	AHAT12090	M12 x 90	✓	--	--	<b>11,60</b>	<b>11,60</b>
	AHAT12100	M12 x 100	✓				
	AHAT12110	M12 x 110	✓				
	AHAT12130	M12 x 130	✓				
	AHAT12140	M12 x 140	✓				
	AHAT12160	M12 x 160	✓	<b>17,19</b>	<u>16,48</u>	<b>11,60</b>	<b>11,60</b>
	AHAT12180	M12 x 180	✓				
AHAT12200	M12 x 200	✓					
AHAT12220	M12 x 220	✓					
AHAT12250	M12 x 250	✓					
AHAT16125	M16 x 125	✓					
AHAT16145	M16 x 145	✓					
AHAT16170	M16 x 170	✓					
AHAT16220	M16 x 220	✓	<b>25,25</b>	<u>30,72</u>	<b>17,19</b>	<u>30,72</u>	
AHAT16250	M16 x 250	✓					
AHAT16280	M16 x 280	✓					
AHAT20170	M20 x 170	✓					
AHAT20220	M20 x 220	✓	<b>34,28</b>	<u>45,04</u>	<b>21,30</b>	<b>42,60</b>	
AHAT20270	M20 x 270	✓					

1 kN ≈ 100 kg

Unterstrichene und kursiv gedruckte Werte geben das Stahlversagen an; die **fett** gedruckten Werte geben das Versagen durch Betonausbruch und die restlichen das Versagen durch Herausziehen an.

**5.3 MAX. EMPFOHLENE ZUGFESTIGKEIT [kN] (bei  $\gamma_F=1.4$ )**

Allgemeine Parameter				Standard-Einbautiefe		Reduzierte Einbautiefe	
Familie	Artikelnr.	Größe	Zulassung	Zuglast	Querlast	Zuglast	Querlast
				N <sub>rec</sub>	V <sub>rec</sub>	N <sub>rec</sub>	V <sub>rec</sub>
MTH	AH06060	M6 x 60	✓	<u>3,78</u>	<u>2,91</u>	--	--
	AH06070	M6 x 70	✓				
	AH06080	M6 x 80	✓				
	AH06090	M6 x 90	✓				
	AH06100	M6 x 100	✓				
	AH06110	M6 x 110	✓				
	AH06120	M6 x 120	✓				
	AH06130	M6 x 130	✓				
	AH06140	M6 x 140	✓				
	AH06150	M6 x 150	✓				
	AH06160	M6 x 160	✓				
	AH06170	M6 x 170	✓				
	AH06180	M6 x 180	✓				
	AH08060	M8 x 60	✓	--	--	4,76	4,85
	AH08075	M8 x 75	✓	<u>6,63</u>	<u>5,31</u>	4,76	4,85
	AH08090	M8 x 90	✓				
	AH08100	M8 x 100	✓				
	AH08115	M8 x 115	✓				
	AH08120	M8 x 120	✓				
	AH08130	M8 x 130	✓				
	AH08155	M8 x 155	✓				
	AH10070	M10 x 70	✓	--	--	6,38	6,38
	AH10080	M10 x 80	✓	9,05	<u>8,40</u>	6,38	6,38
	AH10090	M10 x 90	✓				
	AH10100	M10 x 100	✓				
	AH10120	M10 x 120	✓				
	AH10140	M10 x 140	✓				
	AH10150	M10 x 150	✓				
	AH10160	M10 x 160	✓				
	AH10170	M10 x 170	✓				
	AH10210	M10 x 210	✓				
	AH10230	M10 x 230	✓				
	AH12090	M12 x 90	✓	--	--	8,28	8,28
	AH12100	M12 x 100	✓	12,28	<u>11,77</u>	8,28	8,28
	AH12110	M12 x 110	✓				
	AH12120	M12 x 120	✓				
	AH12130	M12 x 130	✓				
	AH12140	M12 x 140	✓				
	AH12160	M12 x 160	✓				
	AH12180	M12 x 180	✓				
AH12200	M12 x 200	✓					
AH12220	M12 x 220	✓					
AH12250	M12 x 250	✓					
AH14120	M14 x 120	✓	15,22	<u>16,06</u>	--	--	
AH14145	M14 x 145	✓					
AH14170	M14 x 170	✓					
AH14220	M14 x 220	✓					
AH14250	M14 x 250	✓					



Allgemeine Parameter				Standard-Einbautiefe		Reduzierte Einbautiefe		
Familie	Artikelnr.	Größe	Zulassung	Zuglast	Querlast	Zuglast	Querlast	
				N <sub>rec</sub>	V <sub>rec</sub>	N <sub>rec</sub>	V <sub>rec</sub>	
MTH	AH16125	M16 x 125	✓	<b>18,03</b>	<u>21,94</u>	<b>12,28</b>	<u>21,94</u>	
	AH16145	M16 x 145	✓					
	AH16170	M16 x 170	✓					
	AH16220	M16 x 220	✓					
	AH16250	M16 x 250	✓					
	AH16280	M16 x 280	✓					
	AH20170	M20 x 170	✓	<b>24,49</b>	<u>32,17</u>	<b>15,22</b>	<b>30,43</b>	
	AH20220	M20 x 220	✓					
AH20270	M20 x 270	✓						
MTH-A2	MI06045	M6 x 45	[x]	--	--	<b>2,93</b>	<u>2,82</u>	
	MI06060	M6 x 60	✓	<u>4,29</u>	<u>2,82</u>	--	--	
	MI06080	M6 x 80	✓					
	MI06120	M6 x 120	✓					
	MI06140	M6 x 140	✓					
	MI06160	M6 x 160	✓					
	MI06170	M6 x 170	✓					
	MI06180	M6 x 180	✓					
	MI08050	M8 x 50	[x]	--	--	<b>2,15</b>	<b>2,58</b>	
	MI08075	M8 x 75	✓	5,71	<u>5,12</u>	3,57	<b>4,85</b>	
	MI08090	M8 x 90	✓					
	MI08115	M8 x 115	✓					
	MI10070	M10 x 70	✓	--	--	4,76	<b>6,38</b>	
	MI10090	M10 x 90	✓	6,35	<u>8,18</u>			
	MI10120	M10 x 120	✓					
	MI10150	M10 x 150	✓	--	--	5,50	<b>6,61</b>	
	MI12075	M12 x 75	[x]					
	MI12090	M12 x 90	✓	--	--	6,35	<b>8,28</b>	
	MI12110	M12 x 110	✓					
	MI12140	M12 x 140	✓	9,92	<u>11,84</u>	6,70	<b>8,03</b>	
	MI16090	M16 x 90	[x]					
	MI16145	M16 x 145	✓	13,89	<u>22,13</u>	--	--	
	MI16170	M16 x 170	✓					
	MI20120	M20 x 120	[x]	--	--	<b>11,68</b>	<b>28,03</b>	
	MI20170	M20 x 170	✓	19,84	<u>34,54</u>	--	--	
	MI20220	M20 x 220	✓					
	MTH-A4	MIA406045	M6 x 45	[x]	--	--	<b>2,93</b>	<u>2,82</u>
		MIA406060	M6 x 60	✓	<u>4,29</u>	<u>2,82</u>	--	--
MIA406080		M6 x 80	✓					
MIA408050		M8 x 50	[x]					
MIA408075		M8 x 75	✓	5,71	<u>5,12</u>	3,57	<b>4,85</b>	
MIA408090		M8 x 90	✓					
MIA408115		M8 x 115	✓					
MIA410070		M10 x 70	✓					
MIA410090		M10 x 90	✓	--	--	4,76	<b>6,38</b>	
MIA410120		M10 x 120	✓	6,35	<u>8,18</u>			
MIA410150		M10 x 150	✓					
MIA412075		M12 x 75	[x]	--	--	<b>5,50</b>	<b>6,38</b>	
MIA412090		M12 x 90	✓	--	--	6,35	<b>8,28</b>	
MIA412110		M12 x 110	✓					
MIA412140		M12 x 140	✓	9,92	<u>11,84</u>	6,70	<b>8,03</b>	
MIA416090		M16 x 90	[x]					
MIA416145		M16 x 145	✓	13,89	<u>22,13</u>	--	--	
MIA416170		M16 x 170	✓					
MIA420120		M20 x 120	[x]	--	--	<b>11,68</b>	<b>28,03</b>	
MIA420170		M20 x 170	✓	19,84	<u>34,54</u>	--	--	
MIA420220		M20 x 220	✓					

Allgemeine Parameter				Standard-Einbautiefe		Reduzierte Einbautiefe	
Familie	Artikelnr.	Größe	Zulassung	Zuglast	Querlast	Zuglast	Querlast
				N <sub>rec</sub>	V <sub>rec</sub>	N <sub>rec</sub>	V <sub>rec</sub>
MTH-AT	AHAT06060	M6 x 60	✓				
	AHAT06080	M6 x 80	✓	<u>3,78</u>	<u>2,91</u>	--	--
	AHAT06100	M6 x 100	✓				
	AHAT08060	M8 x 60	✓	--	--	4,76	<b>4,85</b>
	AHAT08075	M8 x 75	✓				
	AHAT08090	M8 x 90	✓				
	AHAT08100	M8 x 100	✓				
	AHAT08115	M8 x 115	✓	<u>6,63</u>	<u>5,31</u>	4,76	<b>4,85</b>
	AHAT08130	M8 x 130	✓				
	AHAT08155	M8 x 155	✓				
	AHAT10070	M10 x 70	✓				
	AHAT10080	M10 x 80	✓	--	--	<b>6,38</b>	<b>6,38</b>
	AHAT10090	M10 x 90	✓				
	AHAT10100	M10 x 100	✓				
	AHAT10120	M10 x 120	✓				
	AHAT10140	M10 x 140	✓				
	AHAT10150	M10 x 150	✓				
	AHAT10160	M10 x 160	✓				
	AHAT10170	M10 x 170	✓				
	AHAT10210	M10 x 210	✓				
	AHAT12090	M12 x 90	✓	--	--	<b>8,28</b>	<b>8,28</b>
	AHAT12100	M12 x 100	✓				
	AHAT12110	M12 x 110	✓				
	AHAT12130	M12 x 130	✓				
	AHAT12140	M12 x 140	✓				
	AHAT12160	M12 x 160	✓	<b>12,28</b>	<u>11,77</u>	<b>8,28</b>	<b>8,28</b>
	AHAT12180	M12 x 180	✓				
	AHAT12200	M12 x 200	✓				
	AHAT12220	M12 x 220	✓				
	AHAT12250	M12 x 250	✓				
AHAT16125	M16 x 125	✓					
AHAT16145	M16 x 145	✓					
AHAT16170	M16 x 170	✓					
AHAT16220	M16 x 220	✓	<b>18,03</b>	<u>21,94</u>	<b>12,28</b>	<u>21,94</u>	
AHAT16250	M16 x 250	✓					
AHAT16280	M16 x 280	✓					
AHAT20170	M20 x 170	✓					
AHAT20220	M20 x 220	✓	<b>24,49</b>	<u>32,17</u>	<b>15,22</b>	<b>30,43</b>	
AHAT20270	M20 x 270	✓					

1 kN ≈ 100 kg

Unterstrichene und kursiv gedruckte Werte geben das Stahlversagen an; die **fett** gedruckten Werte geben das Versagen durch Betonausbruch und die restlichen das Versagen durch Herausziehen an.

VERGRÖßERUNGSFAKTOREN FÜR HERAUSZIEHEN UNTER ZUGBEANSPRUCHUNG FÜR HOCHFESTEN BETON			
BETONFAKTOR	C30/37	C40/50	C50/60
Ψ <sub>c</sub> (ungerissen)	1,22	1,41	1,55

## 7. OFFIZIELLE DOKUMENTE

Bei unserer Vertriebsabteilung oder über unsere Website [www.indexfix.com](http://www.indexfix.com) können Sie folgende Dokument erhalten:

- EU-Zulassung ETA 05/0242 für den Einbau in ungerissenem Beton gemäß EAD 330232-00-0601, Option 7, von M6 bis M20.
- Leistungserklärung DoP MTH.
- Erhältlich für das Berechnungsprogramm für Verankerungen INDEXcal.