

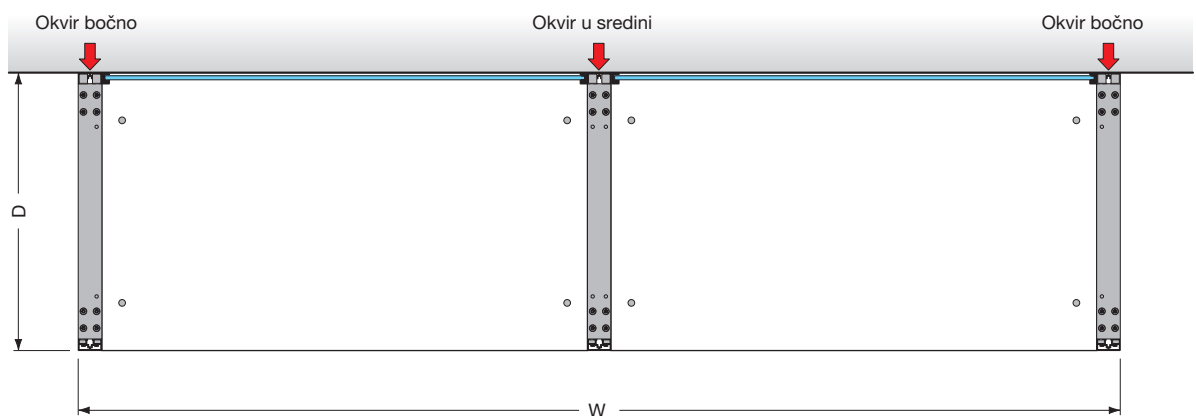

Staklena stražnja stranica

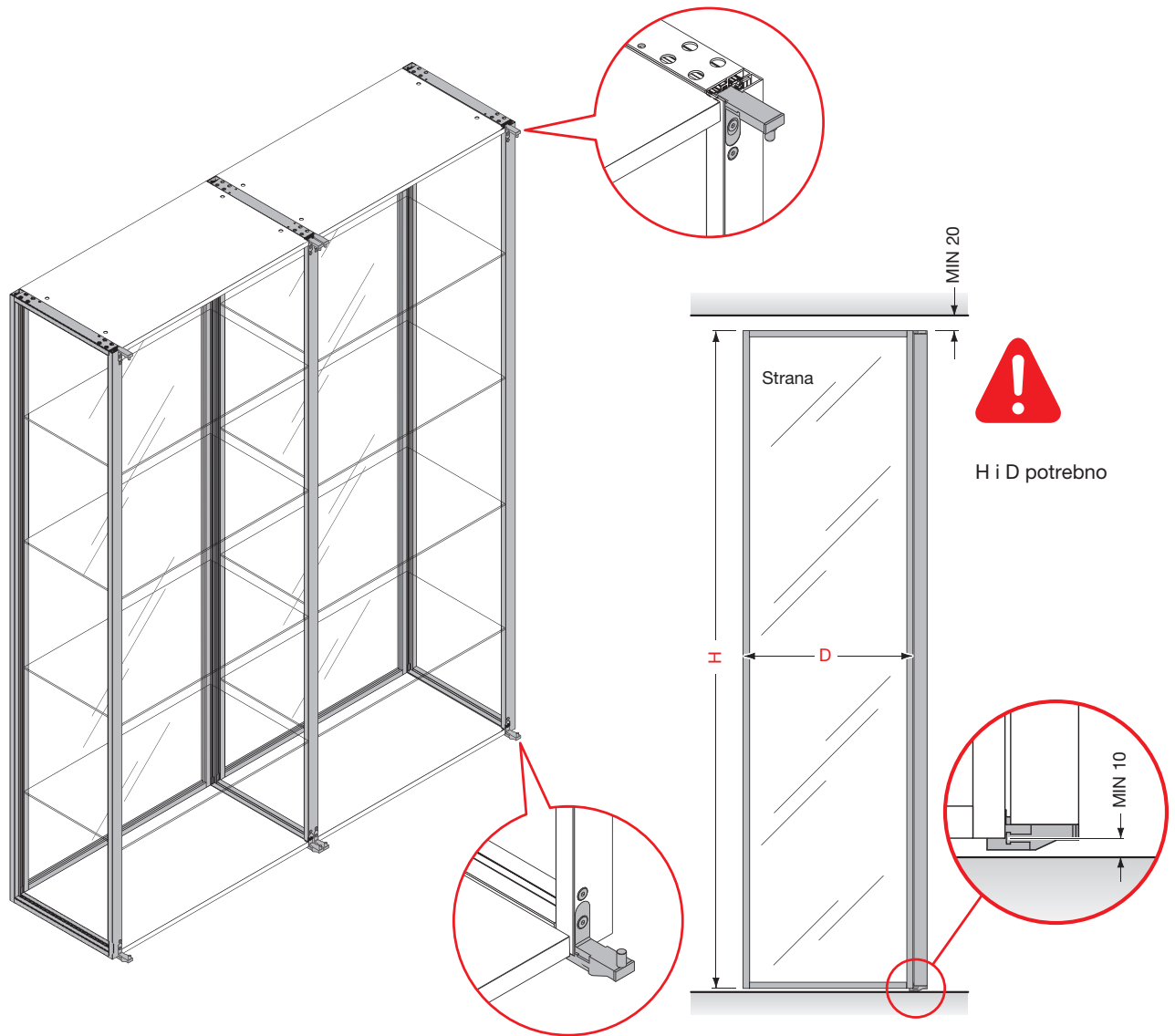

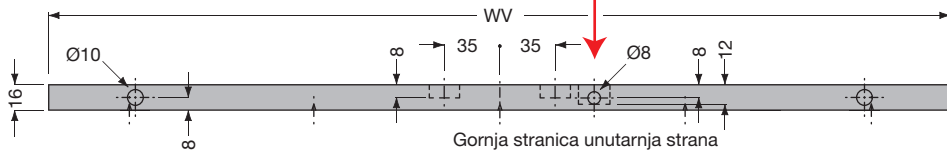

opcija

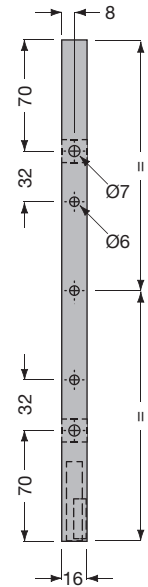
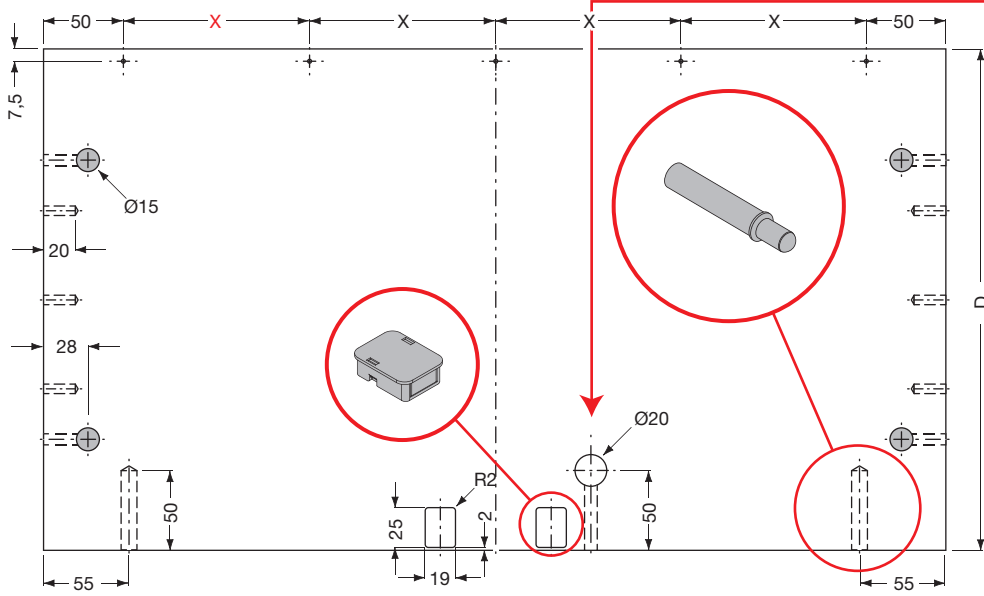
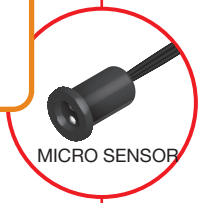

$$X = (WV - 100) : 4$$

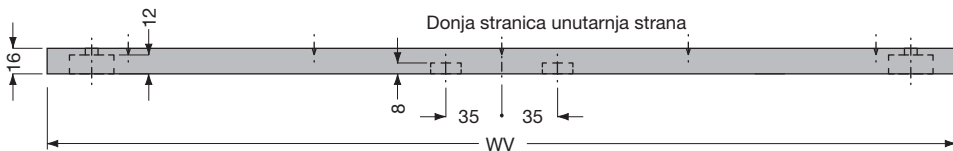
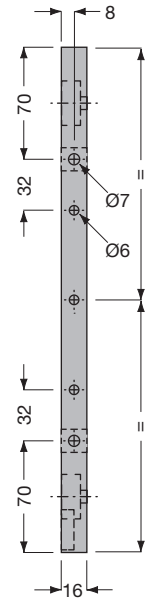
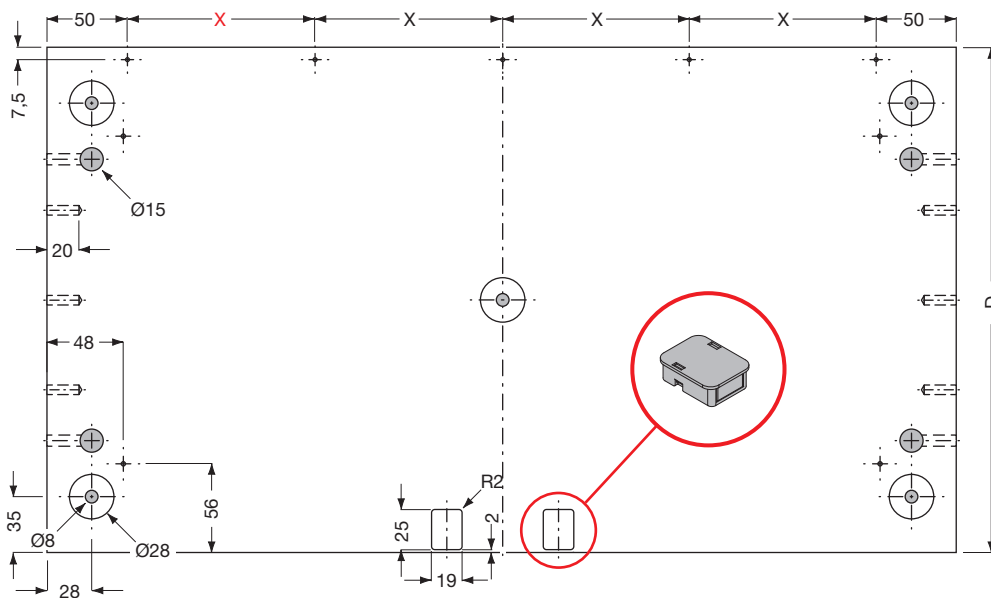

$$X = (WV - 100) : 4$$

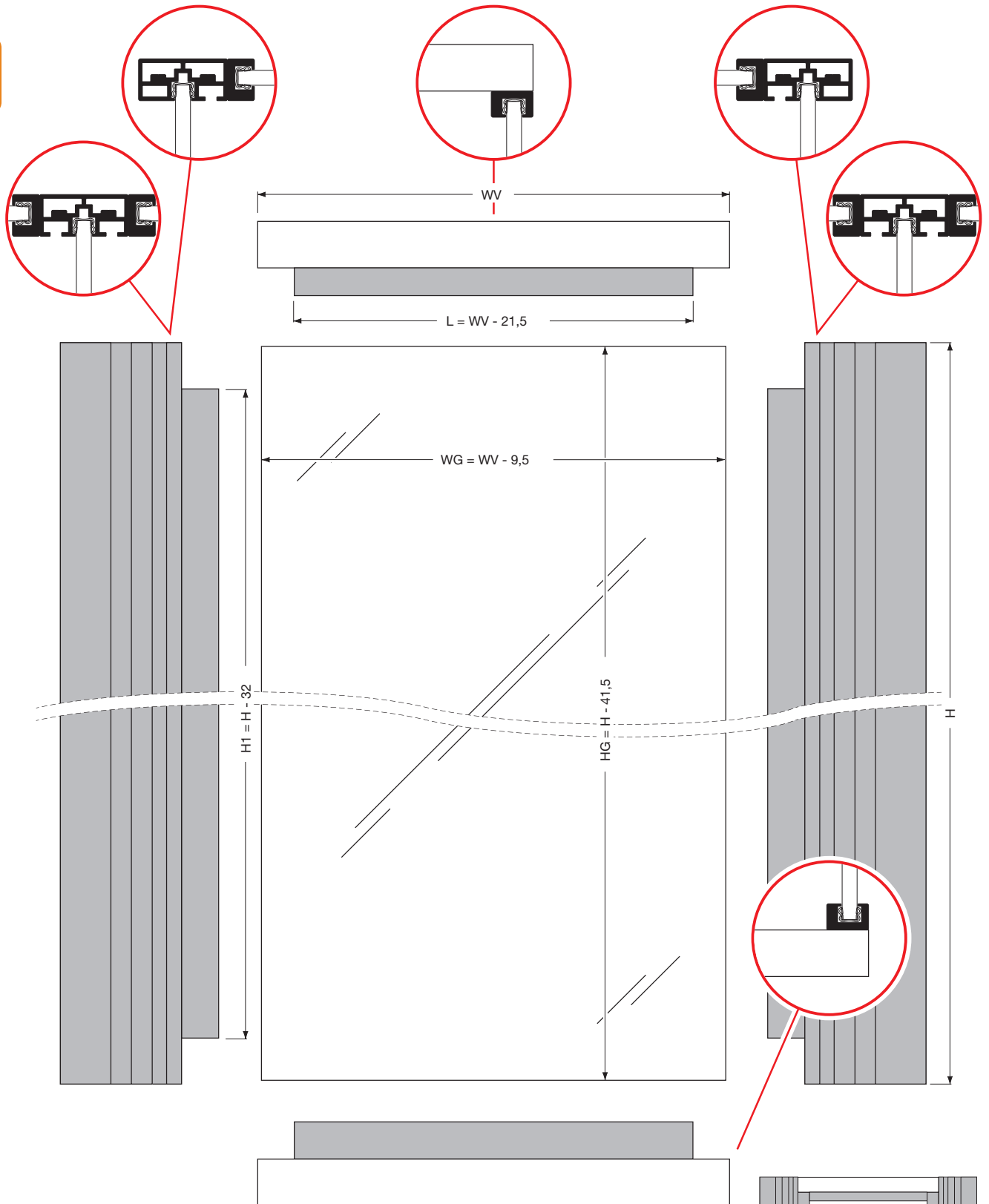

Skraćenice:
L = Duljina profila
WV = Širina otvaranja
WG = Širina stakla
H = Ukupna visina
H1 = Visina profila
HG = Visina stakla



← Unutarnja strana

