

## BLANCO SILGRANIT® PuraDur® II



BLANCO GmbH + Co KG  
 Technischer Kundendienst  
 Tel.: +49 7045 44-81 419  
 www.blanco-germany.com

**BLANCO**



Art.-No.: 511 935



Art.-No.: 513 605

230695 - 05/2013





✓ OK

✗ not OK



1



www.blanco-germany.com

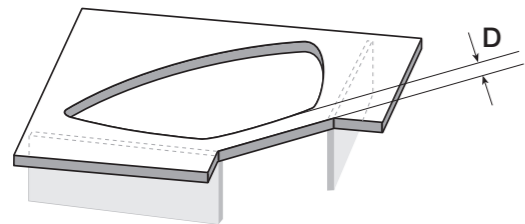
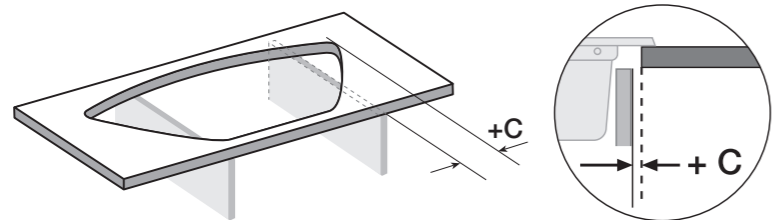
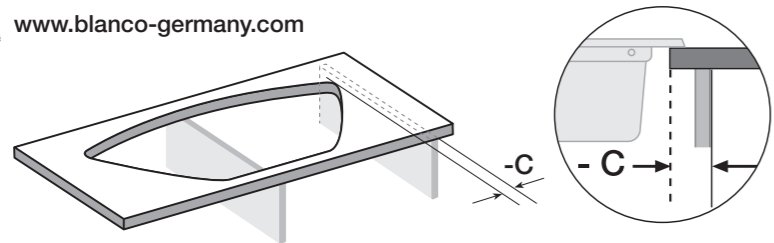

BLANCORONDO Pro Set

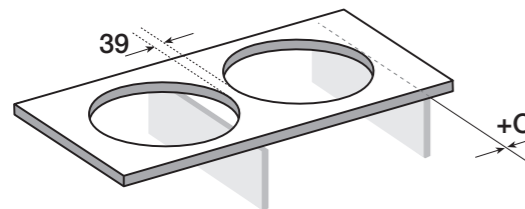

A: +2 mm / -1 mm = OK

B: +2 mm / -1 mm = OK

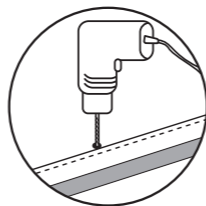
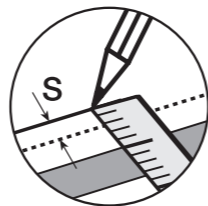
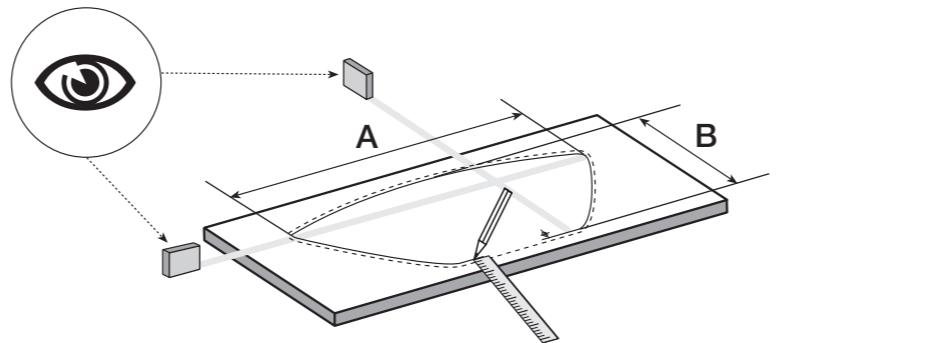
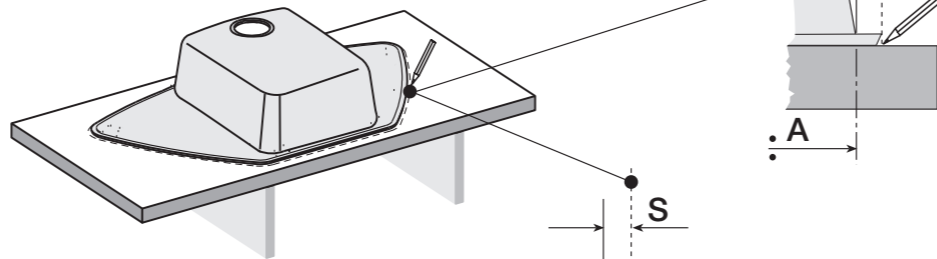

BLANCOVIVA 9 E

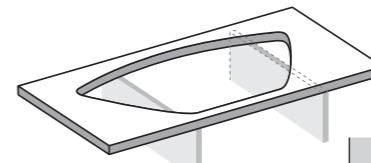
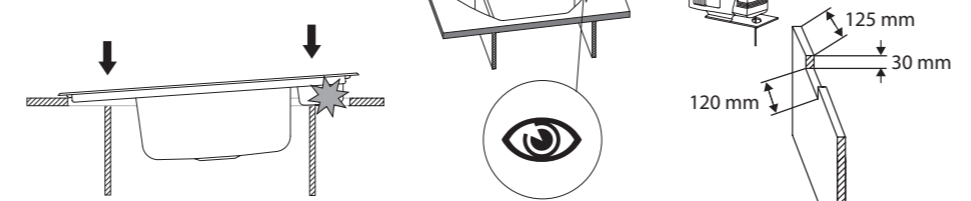

	C	S	+2 mm / -1 mm	
			A	B
BLANCOCRON 6 S	-4 mm	8 mm	958 mm	478 mm
BLANCODELTA	-19 mm	12 mm	1033 mm	551 mm
BLANCOLEXA 9 E	-30 mm	8 mm	1054 mm	494 mm
BLANCORONDO	-10 mm	10 mm	Ø 430 mm	-
BLANCORONDO Pro	+3 mm	12 mm	Ø 456 mm	-
BLANCORONDO Pro Set	+0 mm	12 mm	Ø 456 mm	-
BLANCORONDOVAL 45	+35 mm	8 mm	519 mm	474 mm
BLANCORONDOVAL 45 S	-5 mm	10 mm	760 mm	480 mm
BLANCOVIVA 9 E	+94 mm	10 mm	909 mm	489 mm
BLANCOYOVA XL 6 S	+6 mm	10 mm	980 mm	480 mm
BLANCOZIA 9 E	+125 mm	10 mm	909 mm	489 mm

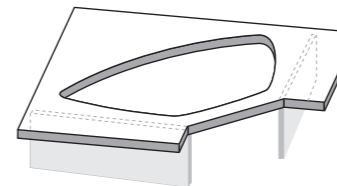

	D	S	+2 mm / -1 mm	
			A	B
BLANCODELTA	120 mm	12 mm	1033 mm	551 mm
BLANCOLEXA 9 E	90 mm	8 mm	1054 mm	494 mm
BLANCOMETRA 9 E	60 mm	10 mm	810 / 810 mm	480 mm
BLANCORONDO	90 mm	10 mm	Ø 430 mm	-
BLANCORONDO PRO	90 mm	12 mm	Ø 456 mm	-
BLANCOZIA 9 E	90 mm	10 mm	909 mm	489 mm