

Potreba miesta v korpuse

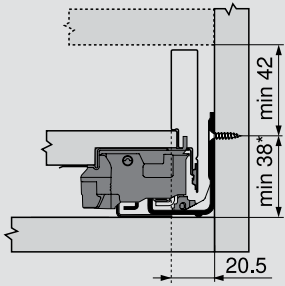

Montážne rozmery čela naskrutkovaním

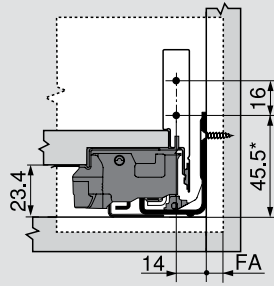

FA Presah čela

Vŕtacie rozmery čela na EXPANDO

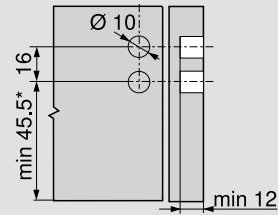

Montážne rozmery chrbta

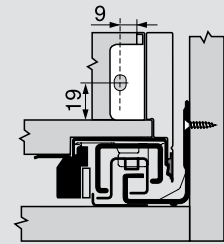

Poloha upevnenia korpusových lišt skrutkami

Menovitá dĺžka NL (mm)

450-500

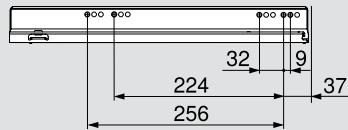

Min. svetlá hĺbka korpusu = menovitá dĺžka NL + 3 mm

Vzdialenosti vŕtania v dne

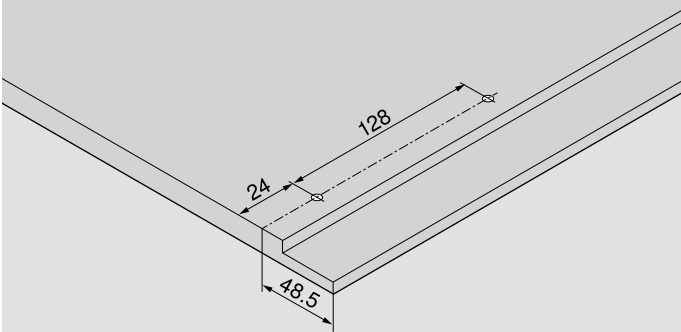

Rozmery prírezov na 16 mm drevotrieskové dosky

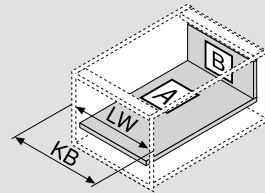

- KB Šírka korpusu
- LW Svetlá šírka korpusu
- NL Menovitá dĺžka

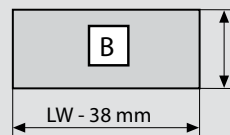

Chrbát  
39 mm

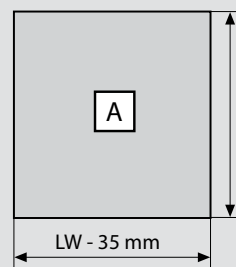

Dno  
Drevený chrbát  
NL - 10 mm

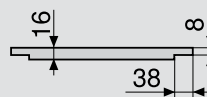

Rozmery polodrážky

\* + 1 mm pri montáži korpusovej lišty na samostatný bok korpusu